

Through PB website

**PRASAR BHARTI**  
**(India's Public Service Broadcaster)**  
**Director General: Doordarshan**  
**Doordarshan Bhawan, Copernicus Marg**  
**New Delhi -110001.**

File No. 19(2)2023-24EI(P)TVDraftspecifications

Dated: 19/12/2024

**Subject: Technical Specification along with Suggestive Bill of Material (BOM) for SITC of Upgradation of Compression chain, Monitoring and Power supply system, Replacement of RF system of C-band Earth Station, Pitampura Delhi and Replacement of High Power Amplifier System of Earth Station, DDK Delhi.**

Ref: - 1. DG: DD letter dated 23/10/2024 (Copy enclosed).

2. DG: DD letter dated 20/11/2024 (Copy enclosed).

3. Specification no: SATD/Compression\_RF\_HPA\_Pitampura\_and\_DDK\_Delhi/Sep\_2024, Dated 20/09/2024 (Copy enclosed).

With reference to DG: DD letter dated 23/10/2024 and DG: DD letter dated 20/11/2024 the Due Date to offer Comments is hereby extended up to 23.12.2024 17:00 hrs. Industry feedback with Budgetary Quotes for above mentioned Technical Specification may be offered by the prospective bidders on or before due date at e-mail ddpurchase401@yahoo.co.in or on following Address:

Assistant Director(Engg)  
Room No. 403,  
Directorate General: Doordarshan,  
Doordarshan Bhawan, Copernicus Marg,  
New Delhi -110001 (India)  
Telephone: 011- 2311 4401

This issue with the approval of competent authority.

Enclosed:- As above.

**Signed by Narendra Kumar Choursiya**

**Date: 19-12-2024 15:00:25**

**Reason: Approved**

(N. K. Chaurasia)

Assistant Director(Engg)

Doordarshan Directorate: Doordarshan



Through PB website

**PRASAR BHARTI**  
**(India's Public Service Broadcaster)**  
**Director General: Doordarshan**  
**Doordarshan Bhawan, Copernicus Marg**  
**New Delhi -110001.**

File No. 19(2)2023-24EI(P)TVDraftspecifications

Dated: 20/11/2024

**Subject: Technical Specification along with Suggestive Bill of Material (BOM) for SITC of Upgradation of Compression chain, Monitoring and Power supply system, Replacement of RF system of C-band Earth Station, Pitampura Delhi and Replacement of High Power Amplifier System of Earth Station, DDK Delhi.**

Ref: - 1. DG: DD letter dated 23/10/2024 (Copy enclosed).

2. Specification no: SATD/Compression\_RF\_HPA\_Pitampura\_and\_DDK\_Delhi/Sep\_2024  
Dated 20/09/2024 (Copy enclosed).

With reference to DG: DD letter dated 23/10/2024, the Due Date to offer Comments is hereby extended up to 04.12.2024 17:00 hrs. Industry feedback with Budgetary Quotes for above mentioned Technical Specification may be offered by the prospective bidders on or before due date at e-mail [ddpurchase401@yahoo.co.in](mailto:ddpurchase401@yahoo.co.in) or on following Address:

Assistant Director(Engg),  
Room No. 403,  
Directorate General: Doordarshan,  
Doordarshan Bhawan, Copernicus Marg,  
New Delhi -110001 (India),  
Telephone: 011- 2311 4401.

This issue with the approval of competent authority.

Enclosed:- As above.

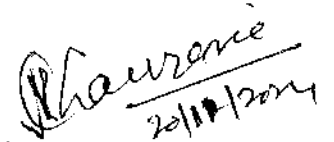
  
20/11/2024

(N. K. Chaurasia)

Assistant Director(Engg)

Doordarshan Directorate: Doordarshan

Through-E-Mail

**PRASAR BHARTI  
(India's Public Service Broadcaster)  
Directorate general of Doordarshan  
Doordarshan Bhawan, Copernicus Marg  
New Delhi -110001.**

File No. 19(2)2023-24EI(P)TV Draftspecifications

Dated : 23/10/2024

**Subject: Technical Specification along with Suggestive Bill of Material (BOM) for SITC of Upgradation of Compression chain, Monitoring and Power supply system, Replacement of RF system of C-band Earth Station, Pitampura Delhi and Replacement of High Power Amplifier System of Earth Station, DDK Delhi.**

The Technical specification of the upcoming tender is enclosed herewith to offer comments/Industry Feedback and budgetary quote by prospective bidders/Firms on or before due date at e-mail ddpurchase401@yahoo.co.in or on following Address:

Assistant Engineer  
Room No. 403,  
Directorate General: Doordarshan,  
Doordarshan Bhawan, Copernicus Marg,  
New Delhi -110001 (India)  
Telephone: 011- 2311 4401

Specification For: **SITC of Upgradation of Compression chain, Monitoring and Power supply system, Replacement of RF system of C-band Earth Station, Pitampura Delhi and Replacement of High Power Amplifier System of Earth Station, DDK Delhi.**

Specification no: SATD/Compression\_RF\_HPA\_Pitampura\_and\_DDK\_Delhi/Sep\_2024  
Dated 20/09/2024

Due Date to offer Comments: **06.11.2024 at 17.00 hrs.**

Encl.: As above (113 Pages)

Signed by Narendra Kumar  
Choursiya  
Date: 23-10-2024 16:45:40  
Reason: Approved  
Assistant Engineer  
For DG:DD

Appendix D

Prasar Bharati  
(India's Public Service Broadcaster)  
DIRECTORATE GENERAL: DOORDARSHAN

**Specifications for SITC of  
Upgradation of Compression chain, Monitoring and Power supply system,  
Replacement of RF system of C-band Earth Station, Pitampura Delhi and Replacement  
of High Power Amplifier System of Earth Station, DDK Delhi**

Specification No.: SATD/Compression\_RF\_HPA\_Pitampura\_and\_DDK\_Delhi/Sep\_2024

Dated: 20/09/2024

*Prasar Bharati*

*for*

*for*

**Specifications for SITC of  
Upgradation of Compression chain, Monitoring and Power supply system,  
Replacement of RF system of C-band Earth Station, Pitampura Delhi and Replacement  
of High Power Amplifier System of Earth Station, DDK Delhi**

**INDEX**

Sl. No.	Item	Page No.
1	Introduction	3
2	Scope of Work	4
3	Work Experience for Vendor and OEM	8
4	Turnkey Implementation and Commissioning	11
5	Technical Specification	19
5.1	Input and Base Band System	19
5.2	Digital Compression System	24
5.3	IF System	44
5.4	RF System	47
5.5	Monitoring System	54
5.6	Measuring System	68
5.7	Power Supply System	72
6	Physical, Environmental & Mech. Specs	81
7	Complement of Equipment	82
8	General	82
9	Annexure-II of Appendix-D	88
10	Annexure-III of Appendix-D	89
11	Annexure-IV of Appendix-D	90
12	Annexure-V of Appendix-D	91
13	Annexure VI of Appendix-D	93
14	Tool Kit Annexure VIII of Appendix-D	94
15	Suggestive Block Schematics - Annexure-VII of Appendix-D (DRG No. 1 to 13)	95-107
16	Suggestive Bill of Material -Annexure-I of Appendix-D	108-113

*Himanshu C*

*Feb*

*3*

## 1. Introduction

This project envisages Supply, Installation, Testing & Commissioning (SITC) for Upgradation of Compression chain, Monitoring and Power supply system, Replacement of RF system of C-band Earth Station, Pitampura Delhi (Refer table 1) and Replacement of High Power Amplifier System of Earth Station, DDK Delhi (Refer table 2).

A. Compression System, IF System, RF System (C Band), Monitoring System and Power Supply system of Pitampura Earth Station is proposed to be provided for uplinking of SDTV & HDTV channels (Anyone standard on any given point of time) with MPEG-2/MPEG-4 compression including 4 Radio Channels and Uplink in DVB-S/DVB-S2 standard. Configuration of major equipment for the proposed Upgradation and Replacement of C Band Earth Station Pitampura is as below:

S. No.	Configuration of Equipment	Uplink Standard	Proposed Configuration of Equipment
1.	Integrated Receiver Decoder (IRD)	SDTV & HDTV	2x(12+2) SDTV & HDTV Redundant Configuration
2.	Encoder Chassis	SDTV & HDTV	(X+2) SDTV & HDTV Redundant Configuration
3.	IP Encapsulator cum Mux	SDTV & HDTV	(1+1) Redundant configuration
4.	Network Management System (NMS) of Compression System		Master+Slave or cluster with Three Client Licenses configuration
5.	Digital Satellite Modulator	DVB-S & S2 Systems	(1+1) Redundant Configuration
6.	RF Up-converter	C Band frequency	(1+1) Redundant configuration
7.	High Power Amplifier	C Band frequency	(1+1) Redundant configuration
8.	Monitoring System consisting of: <ul style="list-style-type: none"> <li>• Receive Antenna System</li> <li>• Uplink to L band converter (TLT)</li> <li>• Downlink to L band converter</li> <li>• L band IRD</li> <li>• A/V Monitors</li> <li>• 70 to L Band converter</li> <li>• Multi viewer</li> <li>• Demodulator</li> <li>• 32 Channel Video logger</li> </ul>	SDTV & HDTV/ C Band frequency	Monitoring System
9.	Power Supply System consisting of: <ul style="list-style-type: none"> <li>• 2x60KVA UPS</li> <li>• 75 KVA AVR</li> <li>• 75 KVA Isolation Transformer</li> </ul>	-	Power Supply System

Note: X= No. of Encoder chassis required as per technical specification of Compression system for SDTV & HDTV channels.

Table 1

**B. Configuration of Replacement of (1+1) High Power Amplifier System of Earth Station at DDK Delhi:**

S. No.	Configuration of Equipment	Uplink Standard	Proposed Configuration of Equipment
1.	High Power Amplifier	C Band frequency	(1+1) Redundant configuration

Table 2

## 2. Scope of Work

The scope of the work at Digital Earth Station at Pitampura (unless otherwise specified) on turnkey basis shall include the following but not limited to (refer drawing no. 1 to 12); and Replacement of HPA System of Earth Station, DDK Delhi on turnkey basis shall include the following but not limited to (refer drawing no. 13):

- 2.1 All the concerned equipment shall capable to take SDTV & HDTV channel without any limitation or requiring any upgradation by way of hardware or software.
- 2.2 Doordarshan is planning to implement DVB-Subtitling, Audio description, EPG, closed captioning etc services in future. Hence, the equipment offered by the bidder shall be capable of carrying these services without any limitation or requiring upgradation by way of hardware, software and their license.
- 2.3 Bidder shall supply, install, test and commission (SITC) 1 set of L Band Router including minimum 16x16 L-Band Input & Output ports, X-Y/Router control panel with cable, dual redundant power supply units and accessories (refer drawing no. 1).
- 2.4 Bidder shall supply, install, test and commission (SITC) Integrated Receiver Decoders (IRDs) in 2x(12+2) configuration for SDTV and HDTV channel (refer drawing no. 1).
- 2.5 Bidder shall supply, install, test and commission (SITC) one set of SD/HD-SDI Router which consist of minimum 64x64 HD-SDI Input & Output ports with X-Y remote control panel and single bus remote control panel. All 64x64 HD-SDI Input & Output ports shall also be capable to take SD-SDI signal without any limitation or upgradation/downgradation by way of hardware and software (refer drawing no. 1).
- 2.6 Bidder shall supply, install, test and commission (SITC) one set of 48 port IP data switch in (1+1) configuration. Each set of IP data switch in (1+1) configuration shall be used for feeding IP input (Audio/Video Content) to the Encoders of compression system and Input & Confidence Monitoring (refer drawing no. 1).
- 2.7 Bidder shall supply, install, test and commission (SITC) one set of compression system having H.264/MPEG-4 and H.265/HEVC compliant Encoders in (X+2) chassis configuration where "X" is no. of chassis comprising of atleast 16 HDTV Encoders with SDI input per stream. "X" no. of these encoder chassis shall also be capable to take at least 32 SDTV signal with SDI input and compress them to MPEG-2 and H.264/MPEG-4 compression format without any limitation or requiring upgradation /downgradation by way of hardware and software (refer drawing no. 2).

*Jimarsh*

*Lok*

*3*



- 2.8 Further, all the above encoder chassis of compression system shall also be capable to take MPEG-2 TS over IP input with decoding of MPEG-2, H.264/MPEG-4-AVC and H.265/HEVC Main 10 compressed contents to baseband signal format. Each encoder chassis with MPEG-2 TS over IP input shall be capable to encode minimum 4 HDTV channel in H.264/MPEG-4-AVC & H.265/HEVC Main 10 (at a time anyone standard); and minimum 16 SDTV channel in MPEG-2 & H.264/MPEG-4 (at a time anyone standard) without any limitation or requiring upgradation/downgradation by way of hardware and software.
- 2.9 Bidder shall supply, install, test and commission (SITC) one set of 48 port IP data switch in (1+1) configuration and shall be used for feeding IP input (Audio/Video/data Content) to (1+1) IP Encapsulator cum MUX system (refer drawing no. 2).
- 2.10 Bidder shall supply, install, test and commission (SITC) one set of IP Encapsulator cum MUX in (1+1) configuration and shall be used for transmission of transport stream (refer drawing no. 2).
- 2.11 Bidder shall supply, install, test & commission (SITC) of Compression Network Management System (NMS) in Master+Slave or Cluster with Three Client Licenses configuration along with 2 nos. of 48 port Network Switch with 3 nos. of 24 port IP Network Switch and 3 nos. of client computers with accessories to control and monitor transport stream. Compression Network Management System (NMS) shall control and monitor all compression equipment (i.e. IRDs, SDI Router, Encoders, Multiplexers, ASI Router, IP data Switch etc) of Compression system (Refer drawing no. 1 & 2).
- 2.12 The bidder shall supply, install, test & commission (SITC) one set of NTP Server (2x1)(refer drawing no. 2).
- 2.13 The bidder shall supply, install, test & commission (SITC) one set of 16 x 16 or better matrix HD-SDI/ASI router with dual redundant power supply, X-Y remote panel and single Bus panel (refer drawing no. 2).
- 2.14 Bidder shall supply, install, test & commission (SITC) DVB-S, S2 (any one at a time) compliant Digital Modulators in (1+1) configuration with IF redundancy switch (inbuilt or external) in Porta-cabin near existing uplink antenna (refer drawing no. 3).
- 2.15 Bidder shall supply, install, test & commission (SITC) RF chain consisting of (1+1) C band Up-converters with RF redundancy switch (inbuilt or external), splitters etc. in Porta-cabin near existing uplink antenna (refer drawing no. 3).
- 2.16 The bidder shall supply, install, test & commission (SITC) High Power Amplifier (HPA) in (1+1) configuration (either Solid State or Travelling Wave Tube) along with waveguide switch, dummy load, dehydrator and associated accessories in Porta-cabin near existing uplink antenna (refer drawing no. 3).
- 2.17 The bidder shall supply, install, test & commission (SITC) High Power Amplifier (HPA) in (1+1) configuration (either Solid State or Travelling Wave Tube) along with

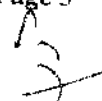
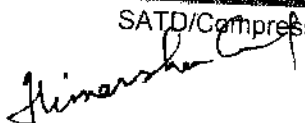

- waveguide switch, dummy load and associated accessories at **Earth Station, DDK Delhi**. HPA shall be identical and inter-changeable with HPA of Earth Station Pitampura. (refer drawing no. 12).
- 2.18 The bidder shall supply, install, test & commission (SITC) 1 set of 32x32 SD-SDI & HD-SDI/ASI compatible router with dual redundant power supply, X-Y remote panel single Bus panel, 17" HD Monitor, 16 channel Audio Monitor, Waveform Monitor, Ampli-speaker and IRDs (IP ASI and L Band Input) for confidence monitoring (refer drawing no. 4).
- 2.19 Bidder shall supply, install, test & commission (SITC) 2 sets of multi-viewer display system (For monitoring of Input source and C band DTH Downlink signal), 55" professional LCD monitor with back-lit LED based display system, 1.2 M PDA, Demodulator, and 32 channel Video logger for monitoring of input source, C band downlink signal and off-air recording of 32 SDTV including 16 HDTV channel with four stereo audio. Each set of Multi Viewer display system shall display minimum 32 SDTV channels including 16 HDTV channels and 4 Radio Service (refer drawing no. 5).
- 2.20 Bidder shall supply, install, test & commission (SITC) for RF uplink and downlink monitoring consisting of Up-converter (70MHz to L-band), Test Loop Translator (TLT-C-band U/L to L- band converter), RF Patch Panel, IRD (L band and ASI input), Spectrum Analyser, 17" TFT monitor, 16 channels Audio (Bar Graph) Monitor and 42/42" nominal LED TV Display for input source & output(D/L) monitoring in Portacabin near existing uplink antenna (refer drawing no. 3).
- 2.21 Bidder shall supply, install, test & commission (SITC) 24 port IP Network Switch and Work Station/ Control Computer/ Client PC for control and monitoring of IF & RF System and Multi-viewer in Porta-cabin near existing uplink antenna (refer drawing no. 2, 3 & 5).
- 2.22 Bidder shall supply, install, test & commission (SITC) measuring equipment (Digital Waveform Monitor, Spectrum Analyser and Portable handheld Ethernet tester as per BOM (refer drawing no. 3&4).
- 2.23 Bidder shall supply, install, test & commission (SITC) 1 set of 42 RU, 19", 1000 mm (depth) equipment ventilated racks for installation of all offered equipment as per BOM. The suggestive number of equipment racks is approx. 6 for compression chain and 2 for IF and RF equipment, however, may increase as per the solution offered. All the racks are to be provided with minimum two nos. single phase MDUs and one no. single phase automatic power transfer/static switch connected between two sources of power supply routed through physically isolated routes.
- 2.24 Bidder shall supply, install, test & commission (SITC) 1 No. of 42 RU, 19", 1000 mm (depth) equipment ventilated rack for installation of High Power Amplifier (HPA) in (1+1) configuration along with waveguide switch, dummy load at **Earth Station, DDK Delhi**. The racks are to be provided with minimum two nos. single phase MDUs and

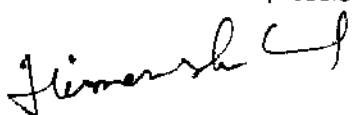



- one no. single phase automatic power transfer/static switch connected between two sources of power supply routed through physically isolated routes.
- 2.25 Bidder shall supply, install, test & commission (SITC) cable trays on top of all equipment racks and as per approved layout of all equipment, all inter connecting cables (Audio/video, power supply, control, data, earthing, sensor cables etc) shall be laid on cable tray and routed from top of racks. Audio/Video cables, SDI, ASI, IP control & data cable should be of different colour and fitted with colour coded ferrule for ease of identification in equipment racks (refer drawing no. 11).
- 2.26 Bidder shall supply, install, test & commission (SITC) minimum seven sets of earth pits. All earth pits shall be extended upto earth terminals mounted on the wall in their respective equipment room i.e. Compression room & Porta-cabin. All electrical equipment and racks shall be directly connected at two points (without loop formation) to Earth Terminals with insulated multi strand copper wire (refer drawing no. 10 & 12).
- 2.27 Bidder shall supply, install, test & commission (SITC) one no. of Isolation Transformer of 75 KVA (3 Phase delta to Star) including power supply cables between DD LT panel & Isolation Transformer system (refer drawing no. 8).
- 2.28 Bidder shall supply, install, test & commission (SITC) one no. of Oil cooled AVR 75 KVA (3 Phase + Neutral) including power supply cables between Isolation Transformer & AVR and AVR & UPS system (refer drawing no. 8).
- 2.29 Bidder shall supply, install, test & commission (SITC) Power supply system includes 2x60 KVA UPS operating in (1+1) redundant, parallel load sharing mode with minimum 15 minutes battery back- up for each UPS with internal isolation transformer of min. capacity 60 KVA at the output of each UPS in power supply room (refer drawing no. 6, 7 & 8).
- 2.30 Bidder shall supply, install, test & commission (SITC) one set of Power Distribution Panels (AVR Output PDP& UPS Output PDP) fitted with industrial type suitable MCCBs, MCBs, on load changeover switch in power supply room which caters the load of all equipment. PDPs shall have provision to feed power supply as per line diagram to existing Uplink Antenna & 2x60 KVA UPS; and output of 2x60 KVA UPS to HPA rack, Antenna Controller in Porta-cabin & SDBs for compression equipment in Compression room (refer drawing no. 8).
- 2.31 Bidder shall supply, install, test & commission (SITC) Sub Distribution Boards (SDBs) fitted with industrial type MCCBs & MCBs in compression room which caters the load of all new equipment and one SDB in Porta-cabin for feeding power supply to Modulators, Upconverters, HPAs, Uplink Antenna and associated system (refer drawing no. 8).
- 2.32 Bidder shall supply, install, test & commission (SITC) Power Supply cables between output of UPS PDP to above said SDBs in compression room and also feed power

*Heinrich*

*Sub*

*3*

supply to SDB installed in Porta-cabin near existing uplink antenna (refer drawing no. 8).

- 2.33 Bidder shall supply, install, test & commission (SITC) Thermometers and Hygrometers with IP output in each rack for monitoring of temperature and humidity of each rack at monitoring room through remote monitoring system (refer drawing no. 9).
- 2.34 Bidder shall provide furniture for installation of various monitoring equipment in monitoring and control area matching with existing furniture.

### 3. Work Experience for Vendor and OEM

#### 3.1 Work Experience for Selection of the vendor:-

- 3.1.1 Bidder must have his local office/authorized representative/dealer in India for after sales service support.
- 3.1.2 The Bidder shall have to meet the following Work experience:-

Work Experience- (Self - certified with relevant documents*)-	One Similar work** of minimum value of 80% of estimated cost of the project. or Two Similar works** each of minimum value of 60% of the estimated cost of project, or Three Similar works** each of minimum value of 40% of the estimated cost of project.
---	--

Note:

- a) \* *Self-certified with Relevant document* means to provide copies of work order/orders clearly mentioning the cost of the project/projects and Receipt Certificate/successful completion certificate/Factory dispatch document/Delivery Challan/Copy of Invoice of the project/projects to various organizations along with the bid.
- b) \*\**Similar works means* Supply and/or services related to any or combination of the following (in any past ten financial years during the period from FYs 2011-12 to 2023-24) :

(1) SITC of Earth Station, (2) Teleport installation, (3) Providing Services of Teleport/VSAT/ DSNG, (4) SITC of DTT/ DVB-C/ VSAT/ IT Based Broadcasting Equipment, (5) SITC of DSNG.

Similar Work may be executed with any Central and State Government agency, PSUs, Private organizations. Bidder should provide all the self-certified relevant documents of such work experience along with their cost in Rupees as per Annexure-VI of Appendix-D.

*Jeinosh*

*PK*

*7*

### 3.2 Work Experience for OEM of Input and Baseband System:-

- 3.2.1 Bidder shall offer L band Router/Matrix of only those OEMs who are having past experience of at least five years of manufacturing and supplying of similar L band Router. List of past supply record of OEM of such equipment to various organizations must be provided.
- 3.2.2 OEM of the offered equipment must have manufactured and supplied the offered equipment to the leading broadcaster as mentioned in the table below in any past five financial years during the period FY 2017-2018 to FY 2023-2024:

S. No.	Offered Equipment	Qty
1	L band Router/Matrix	5 Nos.

- 3.2.3 Copies of supply order and receipt certificate/Factory dispatch document/delivery challan/Copy of invoice of above said quantity of L band Router/Matrix provided in para 3.2.2 to various organizations in any past five financial years during the period FY 2017-2018 to FY 2023-2024 should essentially be submitted along with the bid document.

### 3.3 Work Experience for OEM of Compression System

- 3.3.1 Bidder shall offer compression system of only those OEMs who are having past experience of at least five years of manufacturing and supplying of similar compression equipment. List of past supply record of OEM of such equipment to various organizations must be provided.
- 3.3.2 a) OEM of the offered equipment must have manufactured and supplied the offered equipment to the leading broadcaster as mentioned in the table below in any past five financial years during the period 2017-2018 to 2023-2024:

S. No.	Offered Equipment	Quantity
1	Professional IRDs	100 Nos.
2	IP Encapsulator	10 Nos.

- b) OEM of the offered equipment must have manufactured and supplied the offered equipment to the leading broadcaster as mentioned in the table below in post year 2020:

S. No.	Offered Equipment	Quantity
1	Encoder Chassis*	12 Nos.

\*Out of 12 Nos of Encoder chassis, at least 6 nos. of Encoder chassis should have been supplied for DTH/Earth Station compression system for Broadcast Purpose.

- 3.3.3 Copies of supply order and receipt certificate/Factory dispatch document/delivery challan/Copy of invoice in respect of above said quantity of professional IRDs and IP Encapsulators provided in para 3.3.2.(a) in any past five financial years during the period FY 2017-2018 to FY 2023-2024 and in respect of above said quantity of Encoders Chassis provided in para 3.3.2.(b) in post year 2020 to various organizations should essentially be submitted along with the bid document.

*Shimara*

*Path*

*3*

### 3.4 Work Experience for OEM of IF & RF System (Satellite Modulator, Upconverter, Down Converter, High Power Amplifier):-

- 3.4.1 Bidder shall offer RF system of only those OEMs who are having past experience of at least five years of manufacturing and supplying of similar RF System. List of past supply record of OEM of such equipment to various organizations must be provided.
- 3.4.2 OEM of the offered equipment must have manufactured and supplied the offered equipment to the leading broadcaster as mentioned in the table below in any past five financial years during the period FY 2017-2018 to FY 2023-2024.:

S. No.	Offered Equipment	Quantity
1	Satellite Modulator	10 Nos.
2	C band Upconverter	10 Nos.
3	C Band (Downlink Frequency) to L band Down Converter	10 Nos.
4	High power amplifier (HPA).	10 Nos.

- 3.4.3 Copies of supply order and receipt certificate/Factory dispatch document/delivery challan/Copy of invoice of above said quantity of equipment provided in para 3.3.2 to various organizations in any past five financial years during the period FY 2017-2018 to FY 2023-2024 should essentially be submitted along with the bid document.

### 3.5 Work Experience for OEM of Monitoring System-

- 3.5.1 Bidder shall offer Multi-viewer of only those OEMs who are having past experience of at least five years of manufacturing and supplying of similar Multi-viewer. List of past supply record of OEM of such equipment to various organizations must be provided.
- 3.5.2 OEM of the offered equipment must have manufactured and supplied the offered equipment to the leading broadcaster as mentioned in the table below in any past five financial years during the period FY 2017-2018 to FY 2023-2024:

S. No.	Offered Equipment	Quantity
1	Multi-viewer	10 Nos.

- 3.5.3 Copies of supply order and receipt certificate/Factory dispatch document/delivery challan/Copy of invoice of above said quantity of Multi Viewer provided in para 3.5.2 to various organizations in any past five financial years during the period FY 2017-2018 to FY 2023-2024 should essentially be submitted along with the bid document.

### 3.6 Work Experience for OEM of UPS System

- 3.6.1 OEM of the offered UPS system must have manufactured and supplied atleast 10 Nos of the 60 KVA or higher rating of UPS to the leading broadcaster, IT Industry etc in any past five financial years during the period FY 2017-2018 to FY 2023-2024.
- 3.6.2 Copies of supply order and receipt certificate/Challan/Copy of Invoice of above said quantity of UPS provided in para 3.6.1 to various organizations in any past five financial years during the period FY 2017-2018 to FY 2023-2024 should essentially be submitted along with the bid document.

- 3.7 In addition to above said technical eligibility criteria, Vender/bidder shall also see and ensure to meet the commercial and Financial eligibility criteria pertaining to the a)

*Himanshu*

*folk*

*2*

company existence, b) Annual turnover/Net worth, c) Positive net worth/Profitability, d) Non-Blacklisting certificate, e) ISO certification (If required), f) GFR restrictions/Norms (if required), g) PMA and h) relaxation for Start-up as mentioned in the Appendix A, Appendix B & Appendix C of the bid document.

**3.8** Bidder must have a valid Dealer Possession License (DPL) at the time of submission of bid. A copy of valid DPL should be submitted along with bid.

**3.9 For Consortium/Joint Venture (If applicable):** In case of Consortium/Joint Venture, Vender/bidder shall follow the instructions provided at Appendix-A of the bid document.

#### **4. Turnkey Implementation and Commissioning:-**

The complete project will consist of Supply, Installation, Testing and Commissioning (SITC) of one compression chain and their monitoring system; Power Supply system Replacement of RF system at C Band Earth Station Pitampura Delhi and Replacement of HPA System of C Band Earth Station, DDK Delhi.

- a) The project will be carried out on turnkey basis.
- b) Each and every offered equipment and accessories including software should be from reputed manufacturer and the quoted model should be high class, high MTBF, field proven and in use by leading broadcasters/ organizations.
- c) The system shall be designed to meet the international standards for digital satellite broadcasting known as the 4:2:0, MPEG-2, MP@ML &H.264/MPEG-4, MP@L3 for SDTV and 4:2:0, H.264/MPEG-4, MP@L4 &H.265/HEVC, MP@L4 for HDTV standards.
- d) The bidder has to comply with BIS (Bureau of Indian Standard) certification on invoke to all the offered equipment.

#### **4.1 Input and Base Band System:**

- 4.1.1 Bidder shall lay, integrate and test 2 nos. of 16 port RF Patch panel with RF cables, matching connector (10 nos.) from the existing Patch panel of receive PDA to new 16 port RF patch panel and from RF patch panel to L band splitter. One output of each splitter shall be connected to first 16x16 L band Router and other output of each splitter shall be connected to second Router. Remaining 6 input of each Router shall be terminated on 16 port RF Patch Panel. Output of both L band Router shall be connected to all input IRDs (approximately 20m distance). Bidder shall also provide assorted length of RF cables with matching connectors to connect Splitter/loop-output of IRDs as per site requirement to decode all required channels as per DRG No. 1.
- 4.1.2 Bidder shall lay, integrate and test video cables with matching connectors from all IRDs of TV channels to SD/HD-SDI Input patch panels, SD/HD-SDI Input Patch Panels to SD/HD SDI Routers, Output of SD/HD SDI Routers to Output Patch Panels and finally upto the input of all Encoder chassis.

#### **4.2 Compression System:**

- 4.2.1 Bidder shall lay, integrate and test Ethernet cables with matching connectors from IRDs to (1+1) 48 port IP data switch & 48 port IP network switch and upto the input of

*Glimarsh*

*Ldh*

*1-3*

all Encoder chassis. Further, Ethernet cables with matching connectors shall also be laid, integrate and test from the output of Encoder chassis to (1+1) 48 port IP data switch and upto the input of (1+1) IP Encapsulator.

- 4.2.2 Bidder shall lay, integrate and test video cables with matching connectors from all output port of Multiplexers to 32x2 HD-SDI Input patch panel, HD-SDI Input Patch Panels to 16x16 HD SDI/ASI Router, Output of HD SDI/ASI Router to 32x2 HD-SDI Output patch panel as per DRG No. 2.
- 4.2.3 Bidder shall lay, integrate and test video cables with matching connectors (8 sets) between compression room and Porta-Cabin near existing uplink antenna for carrying SDI & ASI signal (Minimum length-30 mtr) as per DRG No. 3.
- 4.2.4 There shall be two fully populated complete chassis of encoder as redundant. The number of encoders in the redundant chassis shall be populated with same or more number of encoders as in highest populated main encoder chassis as per DRG No. 2.
- 4.2.5 All the Electronic equipment should have necessary control interfaces through RS 232/ RS 422/ RS 485/ RJ45 etc so that they can be interfaced with a Control Computer (Master + Slave or cluster with three client licenses) (NMS) for remote monitoring and control with suitable GUI. The associated software for logging, archiving, monitoring and controlling along with 2 no. of 48 port IP Network Switch, 3 nos. of 24 port IP Network Switch and 3 nos. of client computers with accessories shall also be supplied and installed as per DRG No. 2.
- 4.2.6 Bidder shall lay Ethernet cables and integrate IP network switches of NMS with NTP server as per DRG No. 2.
- 4.2.7 For Integration of equipment, Video Cable, Audio Cable and CAT-6 or better cable (Indoor type) for audio/Video/data/networking should be used. The colour of Audio/Video cables, IP control & data cable should be different and fitted with colour coded ferrule for ease of identification in equipment racks.
- 4.2.8 The system must offer an intuitive user interface as well as remote configuration of all modules, simplifying system deployment and reducing operational routines.
- 4.2.9 IP management and IP data of all the equipment of earth station shall be configured in Class-B broadcast network, so that sufficient IP addresses would be available for Addition/Expansion/Integration of equipment, IP network/and data in future, if required.

### 4.3 Satellite Modulator System and IF Redundancy Switch

- 4.3.1 Bidder shall lay, integrate and test video cables with matching connectors between output of 32x2 HD SDI Patch Pannel in compression room to 32 port SDI/ASI patch panel in Porta-cabin near existing uplink antenna, and its output to DVB-S and DVB-S2 compliant Modulators in (1+1) configuration including IF redundancy switch as per DRG. No. 3.
- 4.3.2 The offered system shall meet the International standards for digital satellite broadcasting having DVB-S and DVB-S2 modulation (one at a time).
- 4.3.3 The offered system would also include the standard accessories supplied by the Manufacturer along with the modulator and IF redundancy switch.
- 4.3.4 Cables are to be laid from Satellite Modulators to IF Redundancy switch and to IF Splitter.

*Jimansh*

*Salh*

*3*



#### 4.4 RF System including Up convertors, RF Redundancy Switch and HPA System:

- 4.4.1 Bidder shall lay, integrate and test RF cables with matching connectors between RF Splitter to (1+1) C Band up converters, and up converter to RF Redundancy switch in Porta-cabin near existing uplink antenna of Earth Station at Pitampura as per DRG. No. 3.
- 4.4.2 Bidder shall lay, integrate and test RF cables with matching connectors between RF Redundancy Switch and RF Splitter, and RF Splitter to the input of High Power Amplifiers (HPAs) in (1+1) configuration including waveguide switch, dummy load and associated accessories fitted in 19" fully wired ventilated racks in **Porta-cabin near existing uplink antenna of Earth Station at Pitampura**. Elliptical Waveguide shall be filled to the output port of HPA Rack through flexible waveguide. Automatic Waveguide Dehydrator shall also be fitted with Elliptical waveguide. The rack is to be provided with minimum two nos. single phase MDUs and one no. single phase automatic power transfer/static switch connected between two sources of power supply routed through physically isolated routes as per DRG. No.3.
- 4.4.3 The bidder shall supply, install, test & commission (SITC) High Power Amplifier (HPA) in (1+1) configuration, waveguide switch, dummy load and associated accessories fitted in 19" fully wired ventilated racks in **Digital Earth Station DDK Delhi**. This rack is to be provided with minimum two nos. single phase MDUs and one no. single phase automatic power transfer/static switch connected between two sources of power supply routed through physically isolated routes. Bidder shall lay, integrate and test RF cables with matching connectors between existing RF Splitter to the input of High Power Amplifiers (HPAs). The existing Elliptical Waveguide shall be filled to the output port of HPA Rack through existing flexible waveguide as per DRG No.13
- 4.4.4 The bidder shall integrate the offered RF System with the existing uplink antenna system and commission it at both sites (C band Earth Station at Pitampura and C Band Earth Station DDK Delhi). Bidder has to offer the solution accordingly.

#### 4.5 Monitoring (Input, Downlink and Confidence) and Measuring System

- 4.5.1 Bidder shall make provision for monitoring of Input/Source signals received from C-band receive PDA through IRDs i.e. MPEG-2 TS over IP output compressed in MPEG-2, MPEG-4 & HEVC format need to be routed to the input of multi-viewer. Dolby Digital (AC-3) 5.1 audio data with metadata are also embedded on to HD-SDI signal which shall be routed to multi-viewer system for monitoring as per DRG No. 1 & 5).
- 4.5.2 Bidder shall supply, install, test & commission (SITC) 2 nos. of C- band receive PDA having size 1.2 M for receiving the downlink signal for downlink monitoring and 32 channel Video Logger.
- 4.5.3 Bidder shall make provision for monitoring of Downlink signals received from 1.2 M C-band receive PDAs need to be routed to Multi-viewer through DVB-S & DVB-S2 demodulator with MPEG-2 TS over IP output. Multi-viewer shall have provision to decode SDTV channel from MPEG-2 & MPEG-4 compressed transport stream and HDTV channel from MPEG-4 & HEVC compressed transport stream. Dolby Digital (AC-3) 5.1 audio data with metadata are also embedded on to HD-SDI signal which shall be routed to multi-viewer system for monitoring as per DRG No. 5).

*Shimara*

*Feb*

*3*

- 4.5.4 Bidder shall make provision for monitoring of Downlink signals received from 1.2 M C-band receive PDAs need to be routed to 32 Channel Video Logger through DVB-S & DVB-S2 demodulator with MPEG-2 TS over IP output.
- 4.5.5 Bidder shall supply, install, test & commission (SITC) two sets of multi-viewer display system for monitoring of TV Channels (One set for Input source and other set for Monitoring of C band Downlink signal). Each set of multi-viewer display system shall be provisioned to decode and display 32 SDTV including 16 HDTV channels and 4 Radio channels.
- 4.5.6 The input source of signal shall be MPEG-2 TS over IP compressed in MPEG-2, MPEG-4 & HEVC format. C band DTH down link signal shall be MPEG-2 TS over IP with MPEG-2, MPEG-4 & HEVC compressed, DVB-S & DVB-S2 standard.
- 4.5.7 Bidder shall provide two sets of 55" LED display system with suitable mounting furniture including video cables to be connected between multi-viewer systems and 55" LED display system.
- 4.5.8 Bidder shall lay, integrate and test Network cables with matching connectors between Computer Control System along with 24 port Network Switch to all the Input, Downlink and Confidence Monitoring equipment as per DRG No. 4 and 5.
- 4.5.9 Bidder shall lay, integrate and test video cables with matching connectors from all output port of 32x32 SD-SDI & HD-SDI/ASI routers with redundant power supply with X-Y remote control panel and single Bus control panel, 3 nos. of 32x2 HD-SDI Patch Panel, 12 port IP Patch Panel, 8 port RF Patch Panel, IRDs (L Band, ASI and IP input), WFM, 17 inch (nominal) color monitor, 16 channel Audio/Video monitor, Ampli-speaker etc. for confidence monitoring setup as per DRG No. 4. There should be provision for monitoring points at the following locations:
- a. **Monitoring of Input IRD (SDI):** SDI (with Embedded audio in MPEG-1 Layer-II, Dolby Digital AC-3 5.1 Audio & Dolby Digital Plus 5.1 audio and metadata) from SDI Routers using 32x32 SD & HD-SDI Router, 17 inch (nominal) colour monitor, 16 Channel Audio/Video Monitor, WFM and Ampli-speaker as per DRG No. 1 & 4.
  - b. **Monitoring of input IRD and Multiplexer (ASI):**
    - (i) ASI output of source IRDs through 32x2 HD-SDI Patch Panel, 32x32 HD-SDI Router, 17 inch (nominal) colour monitor, 16 Channel Audio/Video Monitor, WFM and Ampli-speaker as per DRG No. 1 & 4.
    - (ii) Another ASI Output of Multiplexer from 16x16 SDI/ASI Router through 32x2 HD-SDI Patch Panel and from 32x32 HD-SDI Router, 17 inch (nominal) colour monitor, 16 Channel Audio/Video Monitor, WFM and Ampli-speaker as per DRG No. 2 & 4.
  - c. **Monitoring of input IRD and Encoder (IP):**
    - (i) IP outputs of source IRDs through 48 port Data Switch, connected to 12 port IP Patch Panel and Multi-viewer. Output of 12 Port IP Patch Panel to IRD (IP input). SDI output of IRD shall be monitored through 32x2 HD-SDI Patch Panel, 32x32 HD-SDI Router, 17 inch (nominal) colour monitor, 16 Channel Audio/Video Monitor, WFM and Ampli-speaker as per DRG No. 1 & 4.

- (ii) Another outputs of source IRDs through 48 port Data Switch, connected to Multi-viewer, which shall be monitored at 55" Professional LCD Monitor through Display System as per DRG No. 1 & 5.
- (iii) IP output of Encoders through 48 port Data switch connected to 12 port IP Patch Panel. Output of 12 Port IP Patch Panel to IRD (IP input). SDI output of IRD shall be monitored through 32x2 HD-SDI Patch Panel, 32x32 HD-SDI Router, 17 inch (nominal) colour monitor, 16 Channel Audio/Video Monitor, WFM and Ampli-speaker as per DRG No. 2 & 4.

**d. IF & RF Monitoring and Measurement:** IF & RF monitoring and measurement shall be provided as described below and as per DRG No. 3:

- (i) Monitoring of 70 MHz output of Modulators through IF Patch panel, which is to be converted to L-Band using an Up-converter (70MHz to L-band), IRD (L band input), 17" TFT monitor and 16 channels Audio (Bar Graph) Monitor.
- (ii) Monitoring of output of Up-converters and HPA through RF Patch Panel, Test Loop Translator (TLT- C-band U/L to L- band converter), IRD (L-band input), 17" TFT monitor and 16 channels Audio (Bar Graph) Monitor.
- (iii) Monitoring of LNA output through RF Patch Panel, C-band to L- band converter, IRD (L-band input), 17" TFT monitor and 16 channels Audio (Bar Graph) Monitor.
- (iv) Bidder shall also lay, integrate and test Network cables with matching connectors between Computer Control System along with 24 port Network Switch to Modulators, Up converters, HPAs and all associated equipment for monitoring and configuration of IF & RF System.
- (v) Input of Spectrum Analyser shall be connected to 8 port RF Patch Panel for measurements of RF signal from Upconverters, HPAs and LNA.

**e. Monitoring of input and downlink from compression room to porta-cabin:** SDI output of Display system of Multi-viewer shall be monitored in 40/42" LED TV through 32 port HD SDI Patch panel and SDI to HDMI converter as per DRG No. 3 & 5.

**f. Monitoring of IF & RF from Porta-cabin to Compression room:** SDI output of IRD (L band and ASI input) shall be monitored in 17 inch (nominal) colour monitor, 16 Channel Audio/Video Monitor, WFM and Ampli-speaker through 32 port HD SDI Patch panel (part-2), 32x2 HD-SDI Patch Panel, 32x32 HD-SDI Router as per DRG No. 3 & 4.

4.5.10 Bidder shall lay, integrate and test cables for Temperature and humidity monitoring facility of each equipment rack through remote computer and 24 port Network Switch as per DRG No. 9.

#### **4.6 Power Supply System (Isolation Transformer, AVR, UPS, PDP, SDB, MDU):**

4.6.1 Bidder shall supply, install, test & commission (SITC) one no. of Isolation Transformer of 75 KVA (3 Phase delta to Star) including copper power supply cables between DD LT panel & Isolation Transformer system as per DRG No. 8.

- 4.6.2 Bidder shall supply, install, test & commission (SITC) one no. of Oil cooled AVR 75 KVA (3 Phase + Neutral) including copper power supply cables between (i) Isolation Transformer & AVR, (ii) AVR & AVR PDP (iii) AVR PDP & UPS System (iv) AVR PDP & UPS output PDP (v) AVR PDP & Existing uplink panel in Porta-cabin (vi) UPS output & UPS Output PDP, (vii) UPS output PDP & SDB 1 to 4 (viii) SDB 1 to 4 & all racks as per DRG No. 8.
- 4.6.3 Bidder shall supply, install, test & commission (SITC) 2x60 KVA UPS operating in (1+1) redundant, parallel load sharing mode with 15 minutes (minimum) battery back-up for each UPS with internal isolation transformer of min. capacity 60 KVA at the output of each UPS in the power supply room.
- 4.6.4 Bidder shall supply, install, test & commission (SITC) Power Distribution Panel (AVR PDP) fitted with industrial MCCBs, & MCBs in power supply room which caters the load of all equipment. Another Power Distribution Panel (UPS output PDP) fitted with Change over switch, industrial MCCBs & MCBs in Compression Room as per DRG No. 8.
- 4.6.5 Bidder shall supply, install, test & commission (SITC) the Sub Distribution Boards (SDBs) fitted with industrial MCBs in compression room & Porta-Cabin which caters the load of all equipment as per DRG No. 8.
- 4.6.6 Bidder shall supply, install, test & commission (SITC) two nos. single phase MDUs (minimum) in each rack for providing redundant power supply to equipment as per DRG No. 8.
- 4.6.7 Bidder shall provide power supply in each rack and terminated on industrial type 3 Pin female connector to be mounted near each rack and shall be connected to MDUs for further feeding to equipment.
- 4.6.8 Bidder shall provide Power Supply to HPA Rack from existing SDB at **Earth Station DDK Delhi**. HPA rack shall be directly connected at two points to Earth Terminals with insulated multi strand copper wire (25 sq mm minimum) with copper lugs at both ends as per DRG No. 13.
- 4.6.9 Bidder shall supply, install, test & commission (SITC) Thermometers and Hygrometers with IP output in each rack for monitoring of temperature and humidity of each rack at monitoring room through remote monitoring system as per DRG No. 9.
- 4.6.10 Bidder shall assess the electrical load of equipment installed in Power Supply Room, Compression room and Porta-cabin, required length & rating of power supply cables. Bidder shall provide assorted length of copper power supply cables with minimum 50 percent (nominal) load margin for interconnecting/integrating equipment as mentioned in point no 4.6.2.
- 4.6.11 Bidder shall supply, install, test & commission (SITC) minimum seven sets of earth pits. All earth pits shall be extended upto earth terminals mounted on the wall with insulated copper strip (75 Sq.mm minimum) in their respective equipment room i.e. Compression room & Porta-cabin. All electrical equipment and racks shall be directly connected at two points (without loop formation) to Earth Terminals with insulated multi strand copper wire (25 sq mm minimum) with copper lugs at both ends as per DRG No. 10 & 12.

*Jimarsh U*

*SA*

*3*

4.6.12 Bidder shall affix permanently in a conspicuous position a danger notice in Hindi or English adequate number of Danger/Caution board on all the PDP/SDB etc. to effectively warn individuals of high-voltage electrical hazards and promote safety.

4.6.13 The offer shall include supply, installation, testing and commissioning (SITC) of the setup, complete in all respects. A suggestive block schematic is provided to give a general idea about the intended configuration. A complete schematic of actually proposed implementation including power supply system should be submitted by the bidder along with the quote.

#### 4.7 System Requirements:

- 4.7.1 The bidder must ensure completeness of the envisaged Upgradation of Compression chain, Monitoring and Power supply system, Replacement of RF system of C band Earth Station in all respects. The envisaged C band Earth Station set up should be completed and fully wired for all the equipment fitted in 19" standard racks. The offered system must have enough flexibility in adapting the changing requirements from the technical and operational point of view. The bidder should submit detailed schematics and layouts for proposed solution based on the offered equipment along with the offer.
- 4.7.2 In order to ensure the completeness of the scope of system, any additional equipment/accessories which bidder feels necessary to complete the configuration should also be quoted. However, in such case they should provide proper justification for the additional equipment required.
- 4.7.3 Bidder shall submit only one solution (Single BOM) for the offered system. Bid with multiple options against any requirement is liable to be rejected. BOM shall not contain any optional items as an alternative for any line entry item. However, bidder can offer additional accessory items as options for performance improvement of main line entry item of same make.
- 4.7.4 Each offer should be complete in all respect. Incomplete & non-compliant offers will be rejected summarily, without making any references to bidder.
- 4.7.5 Bidder may have to demonstrate the features of equipment offered as and when asked as part of technical evaluation of tender including statistical multiplexing in MPEG-4/HEVC compression format for 32 SDTV/16 HDTV channels in full resolution per transport stream. However, it will not bestow any right of acceptance of the bid.
- 4.7.6 In the process of technical evaluation, Doordarshan may ask for any clarification/query as required through e-mail/FAX/Post, which shall be treated as a part of tender and invariably attended and replied by the bidder within the time stipulated therein.
- 4.7.7 Cross reference in respect of supporting documents, should be given with proper page number and volume no. etc. If required Doordarshan may also ask for any other supporting document to ascertain the claim of bidder and their OEM.
- 4.7.8 All software being offered, are to be licensed to Doordarshan on perpetual basis without specifying any time limit or without specifying any end of life of the software. Software upgrades within five years of installation i.e. warrantee period should be supplied free of cost.
- 4.7.9 The bidders may visit the site for their assessment of existing facilities and requirements before submission of the bid. Bidders desiring to visit the site must

*Signature*

*Signature*

*Signature*

- submit the request to Doordarshan one week in advance with the details of the persons for facilitating the visit.
- 4.7.10 Cost of any other work, consultancy and material required for completing the installation & commissioning of the compression, monitoring and Power Supply system should be taken into account and clearly mentioned while submitting the tender.
- 4.7.11 The local office/authorized representative/dealer will be the nodal point for resolving issues related to installation, commissioning and after sales support. Details of the OEM office and its location are to be provided along with bid.
- 4.7.12 The offer should clearly specify the list of equipment hardware, interfaces, cables etc and associated software provided with the Remote Computer System for interfacing it with different components of the chain.
- 4.7.13 To avoid any delay due to inter-dependent activities like site readiness, providing power supply etc, the bidder should submit time frame for completing the activities up to the commissioning of the set-up on a PERT chart starting from date of issue of Purchase Order (P.O.) (i.e. DD/MM/YYYY)+ along with bid.
- 4.7.14 As an SITC contract, all supplied equipment are to be installed, tested and commissioned at site mentioned above, by the Bidder. The cost of any other interconnecting material and labour required for laying of cables, Earthing etc, should be included in the tender.
- 4.7.15 The successful bidder will be solely responsible for commissioning and operationalisation of Input and Baseband System, Compression System, Monitoring System, RF System and Power Supply System to the satisfaction of Doordarshan.
- 4.7.16 System/equipment (Equipment, Panels, Board, Motor controllers etc.) should be offered along with its frame/housing and other accessories which are necessary to meet the specifications/requirement and for the full exploitation of the equipment.
- 4.7.17 The routing of wiring between racks to be done from the Top of the racks.
- 4.7.18 The bidder should specify the hardware limitation if any.
- 4.7.19 The system must offer an intuitive user interface as well as remote configuration of all modules, simplifying system deployment and reducing operational routines.
- 4.7.20 The layout plan of equipment of Input and Base band system, Compression system and Monitoring system, RF System, Power Supply system, racks, electrical diagram, PDP, SDB layout and other drawings need to be submitted for approval of Doordarshan before execution of SITC work at site.
- 4.7.21 A suggestive block schematic is provided in annexure –VII of Appendix-D (DRG No. 1 to 13) to explain the full scope of the work and give a general idea about the intended configuration. A complete schematic of actually proposed implementation should be supplied along with the quote. Physical topography may be different than the suggestive block diagram but it should meet the project objectives.
- 4.7.22 The successful bidder will be required to print and display the Final laminated Technical Block diagram and detailed Line diagrams (in color) of adequate (A1 or bigger) size for all the modules of the final solution in the facility after the completion of the installation. One set shall be mounted on wall and other for record at Station. The



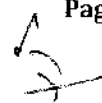

soft editable copy of the Technical Block diagram and detailed Line diagrams (in color) shall also be provided.

## 5. Technical Specification of Major Equipment

### 5.1 Input and Base band System

The L band input signal will be received from L band 16 port Patch Panel of Receive Antenna and it will be routed through L band splitter to L band Router. The input and base band system will consist of:

- (a) 16x16 L band Router
- (b) Integrated Receiver Decoder (IRD) for SD and HD channels

#### 5.1.1 16x16 L Band Router

##### A. General

- (i) L band signal shall be received through RF cable from LNBC of C band receive antenna and connected to L band Router through L band splitter. The output of L band router shall be connected to IRDs.
- (ii) Router should have Full fan out (splitting) facility such that it can be configured to route any of the input (16 input) carrying L band signal to any or all of the output (16 no. outputs).
- (iii) It should have dual redundant Power supply unit.
- (iv) It should have hot swappable frame controller card or CPU Card.
- (v) The unit shall be able to provide DC power to LNBCs either through inbuilt Power Supply or Power Supply Unit of the same make as of router.
- (vi) Configuration & Control of the L-band router (LBR) should be through OEM(Router) supplied NMS apart from the manual control through external control panel or control panel on router or front panel touch screen.

##### B. Specification

S. No.	Parameter	Specification
1	Operating frequency	950 to 2150 MHz
2	Isolation	
a	Input to input	60dB (min.)
b	Output to output	60 dB (min.)
c	Input to output	50 dB (min.)
3	Return loss	
a	Input return loss	10 dB (min.)
b	Output return loss	10 dB (min.)
4	Input and output RF Connector	Type "F/BNC"
5	Impedance	75 ohm
6	Remote control	RS 232 or RS 422/485 or RJ45 or other

#### 5.1.2 Integrated Receiver Decoder (IRD)

##### A. General

- (i) The professional IRDs should receive the L band input and give digital (SD-SDI, SD-SDI with Embedded Audio, AES/EBU, HD-SDI, HD-SDI with

- Embedded Audio), ASI outputs and MPEG-2 TS over IP output with multiple services filtering facility and bulk decryption.
- (ii) One SD-SDI down converted output of HD-SDI should be available.
  - (iii) IRD should be able to carry out multiple services filtering on IP output port.
  - (iv) IRD should have provision to enter or edit all the parameters for perfect reception of the signals through either front control panel display or web browser.
  - (v) There shall be a provision for observing BER & signal level or C/N & C/N margin or Eb/No & Link Margin for DVB-S mode of operation and PER & signal level or C/N & C/N margin or Es/No & Link Margin for DVB-S2 mode of operation through either front control panel display or web browser.
  - (vi) IRD should be able to bulk descrambler of BISS mode 1 and BISS-E signals.
  - (vii) There should be at least one vacant slot (CI slot) for each channel of conditional Access System for descrambling all MPEG-2, H.264/MPEG 4 & H.265/HEVC encoded channel and DVB-S & DVB S2 compliant services. Each CI slot should be integrated/configured with atleast two L band Input port.
  - (viii) There should be direct decompression of ASI to SDI i.e. not through analog to Digital conversion.
  - (ix) IRD should be able to store at least 10 presets channels configuration in memory.
  - (x) It should be possible to configure and monitor the IRD through NMS.
  - (xi) IRD should be able to generate and save logs for alarms and warning through NMS of compression system.
  - (xii) IRD should have facility to pass ancillary data like closed captioning, EIA 608/708, DVB-Teletext, DVB- subtitle, DPI SCTE-35 etc.
  - (xiii) Bidder may offer Server based professional IRDs in place of Hardware based professional IRDs. Each server chassis may accommodate two to four professional IRDs.

#### B. RF Parameter Specifications

Sl.	Parameters	Specification
1	Input Frequency Range	950 - 2150 MHz
2	No. of Inputs	2 (min.)
3	Tuning Step Size	125 kHz, Max.
4	Satellite Frequency Band	C- Band & Ku-Band, Selectable
5	Input Impedance	75 Ohms
6	Input Connector	F-Type female
7	Input Power Range	-30 to -60 dBm per carrier
8	Image Rejection	>30 dB
9	Input Return Loss	9 dB Min.

*Jimanshu*

*fill*

*3*



10	Noise Figure	15 dB Max.
11	AFC Tuning Range	$\pm 5$ MHz
12	De-Modulation Method	DVB-S QPSK, DVB-S2 QPSK and 8PSK
13	Variable Symbol Rates	1.0 to 40 M Symbol /sec for ( DVB-S) 1.0 to 40 M Symbol /sec for (DVB-S2)
14	Convolution Inner FEC selectable	R= 1/2, 2/3, 3/4, 5/6,7/8 (DVB-S, QPSK), R=1/2, 3/5, 2/3, 3/4, 4/5,5/6, 8/9, 9/10 (For DVB-S2, QPSK) R= 3/5, 2/3, 3/4, 5/6,8/9,9/10 ( DVB-S2, 8PSK)
15	IF Filter Bandwidth	Automatic Selection (dependent on Symbol Rate).

### C. ASI Input and ASI Output Transport Stream specification

Sl. No.	Parameters	Specification
<b>A</b>	<b>ASI Input</b>	
1	Format	MPEG-2 TS over ASI on BNC
2	Quantity for ASI Input	Minimum one no. on BNC
<b>B</b>	<b>ASI Output</b>	
1	Format	MPEG-2 TS over ASI on BNC
2	Quantity	Minimum one no. on BNC

### D. Audio and Video Decompression Parameters

Sl.	Parameters	Specification
1	Video Resolution (all resolutions shall be capable of I, P & B frame decoding, other standard solution should be selectable)	i) For SDTV 720 X 576 544 X 576 480 X 576 ii) For HDTV 1920x1080 1440x1080
2	Video Decompression Type	i) SD MPEG-2, MP@ML, 4:2:0 ii) SD MPEG-2, 422@ML, 4:2:2 iii) SD MPEG-4, MP@ L3, 4:2:0 iv) SD MPEG-4, Hi422@ L3, 4:2:2 v) HD H.264 MP@ Level 4.0 4:2:0 vi) HD H.264 Hi422 @ Level 4.0, 4:2:2 vii) HD H.265/HEVC Main 10 4:2:0
3	Television Standard	PAL-B (EN50083-9)
4	Audio Decompression Type	i) MPEG-1 Layer-II audio ii) HE AAC (MPEG 4) v1 & v2 5.1 Audio iii) Dolby Digital (AC-3) 5.1 Audio iv) Dolby Digital plus 5.1 Audio (E-AC-3) (Pass through) v) Linear PCM (Pass Through)

	vi) Dolby E (Pass-through)
--	----------------------------

### E. Digital Video output Specifications (SD-SDI & HD-SDI)

Sl.	Parameters	Specification
1	SD-SDI and HD-SDI O/P Serial Interface	SMPTE 292M-1485 Mbps SMPTE 259M-(10 bit) 270 Mbps
2	SD-SDI with Embedded Audio	SMPTE 272M
3	HD-SDI with Embedded Audio	SMPTE 299 M
4	Video Output Format	HD-SDI and SD-SDI
5	Connector Type	BNC (75 Ohms)
6	Quantity	Minimum 2 Nos. of digital output compliant to ITU-R BT.656 Standard or latest
7	Level	800mV p-p for SDI As per ITU-R BT.601 (part A) and ITU-R BT.709

### F. Digital Audio Output Specifications

Sl.	Parameters	Specification
1	Output Format	i) AES/EBU or AES3 id ii) HE AAC (MPEG 4) v1 & v2 5.1 Audio iii) Dolby Digital (AC-3) 5.1 Audio iv) Dolby Digital Plus 5.1 Audio (E-AC-3) (Pass-through) v) Linear PCM (Pass Through) vi) Dolby E (Pass-through)
2	Load Impedance	75/110 Ohms
3	Connector Type	BNC Female/XLR male Socket or with suitable XLR adapter (i.e. no terminal block)
4	Number of Output	4 Stereo Channels

### G. LNB Power Supply & Control

Sl.	Parameters	Specification
1	LNB Voltage	+ 13 V (Vertical) and 18 V (Horz.) polarizations switching or 19 V fixed.
2	Power Consumption	300 mA. (Max.)
3	Over Current and short circuit protection	Fold back current limiting.
4	LNB Power Supply & Control	Receive Polarization Control by electrical Command Via LNB-IF feeder (High & Low band switching Pulse for Ku-Band operation).

### H. IP Input (TS & Data) and IP Output (TS & Data) specification

Sl. No.	Parameters	Specification
<b>A</b>	<b>IP Input</b>	
1	Format	MPEG-2 TS over IP (MPTS and SPTS ) on Ethernet
2	Quantity for IP Input	Minimum two no. RJ 45 if unidirectional ports.

*Shinash*

*Feb*

*2*

		otherwise minimum one number RJ 45 if Bi-directional port
<b>B</b>	IP Output	
<b>1</b>	Format	MPEG-2 TS over IP on Ethernet with multiple services filtering facility and decryption
<b>2</b>	Quantity for IP Output	Minimum two no. RJ 45 if unidirectional ports, otherwise minimum one number RJ 45 if Bi-directional port.

**I. Size**

Sl. No.	Parameters	Specification
1	Mount	19" Rack Mount

**J. Hardware of Server in case of Server Based Professional IRDs**

(a)	General Feature:
i	Bidder may offer server based professional IRDs in place of Hardware based professional IRDs. Each Chassis may accommodate two to four professional IRDs.
ii	CPU/Chipset of server should have facility to enable an environment where applications can run within their own space, protected from all other software on the system.
iii	CPU/Chipset of server should have security feature that can reduce exposure to viruses and malicious-code attacks and prevent harmful software from executing and propagating on the server or network.
iv	CPU/Chipset of server should have facility of Secure Key consisting of a digital random number generator that creates truly random numbers to strengthen encryption algorithms.
v	CPU/Chipset of server should have Thermal Monitoring facility to protect the processor package and the system from thermal failure.
vi	The offered processor of server should be scalable, high quality, robust with efficient performance.
vii	Each server of software based professional IRDs should be designed with 85 percent (Max.) CPU loading.
viii	CPU of server shall be similar to Intel Xeon Gold series / AMD EPYC 3 <sup>rd</sup> Generation Series or better and the launch date of CPU of offered server should not be prior to year 2021.
ix	Facility to store the last configuration in the software based professional IRDs.





<b>(b) Hardware Feature:</b>		
<b>S. No.</b>	<b>Parameter</b>	<b>Specification</b>
<b>A. Performance of Central Processing Unit</b>		
1	No. of Core	24 (Min) per CPU
2	No. of Thread	48( Min.) per CPU
3	Processor Base Frequency	2.60 GHz or better
4	No. of CPU	One or more
<b>B. Memory Specification</b>		
5	RAM	DDR4 or better, 64 GB or more
6	Storage Memory	SSD, 240 GB (Min.) in Raid 1 Configuration
<b>C. Operating System</b>		
7	Operating System	Linux
<b>D. Ethernet Network</b>		
8	No. of Ports (Duplex) in Server	i. Minimum one physical (RJ 45) bi-directional port of 1 Gigabit for Input ii. Minimum two physical (RJ 45) bi-directional port of 1 Gigabit for output iii. Minimum one physical (RJ 45) bi-directional port of 1 Gigabit for Management & Control
<b>E. PCI slot</b>		
9	PCI slot	2 nos. or more
<b>F. Operating Environment</b>		
10	Operating Temperature	10 to +35 °C
11	Humidity	10% to 90% non-condensing

## 5.2 Digital Compression System

- i) The baseband and MPEG 2 TS over IP signals to the Input of the Encoders are to be brought from IRDs installed in Input rack via SDI Router & IP Switch. All the compression equipment should preferably be from one OEM/company or approved by OEM of compression system, for ease of operation, networking and full automation. The system management should be through NMS. The compression system shall comprise basically a minimum of the following equipment:
- 64x64 SD/HD-SDI Routing Switcher
  - Chassis consisting of multiple MPEG-2 & MPEG-4 SDTV and MPEG-4 & HEVC HDTV Video Encoder
  - IP Encapsulator cum Multiplexer for Statistical Multiplexing
  - IP Data Switch
  - Compression Control system Computer (Hardware and Software) i.e. Network Management System (NMS)
  - 16 x 16 or better matrix of SDI/ASI Router
  - Network Time protocol (NTP) Server

*Jimarsh*

*feh*

*7*

- ii) The compression system should have facility to insert Logo (JPEG/PNG, GIF format) for each channel either in encoder or in multiplexer. Alternatively, separate logo inserter unit can also be offered.
- iii) All the Compression equipment like SDI Router, Encoders and IP Encapsulator cum Multiplexer, IP Switches, ASI Router etc shall be compatible with IP based interface.
- iv) Compression system (either in Encoder or IP Encapsulator cum Multiplexer) should have BISS-1 and BISS-E encryption facility to encrypt all the services with enable & disable facility.
- v) All the electronic equipment should have necessary control interfaces through RS 232 / RS 422/ RS 485/ RJ45 etc so that they can be interfaced with a Control Computer for remote monitoring and control with suitable GUI. The associated software for logging, archiving, monitoring and controlling along with the accessories should also be made available.

### 5.2.1 64 x 64 SD/HD-SDI Routing Switcher

#### A. General:

The routing Switcher should be very reliable and able to be used for selection of any one of the 64 HD-SDI input signals to 64 HD-SDI different destinations. All 64 x 64 input and destinations shall also be SD-SDI. The equipment so offered should be for professional set-up applications. The Router has to be quoted with X-Y and Single Bus Remote Control Panels.

#### B. Essential features:

- (i) The routing switcher electronics should be capable of being mounted in a standard 19" rack frame.
- (ii) The rack frame should be modular to house input, output, control and power supply modules.
- (iii) The switcher shall handle HD-SDI & HD-SDI with embedded audio, SD-SDI & SD-SDI with embedded audio and ASI signal for routing from input to output destinations of their respective port. The switching should take place during the vertical interval period.
- (iv) The switcher should have storage facilities for control information, so that in case of power supply failure, the status of the switcher output should remain unchanged when the power supply is restored.
- (v) The switcher should have redundant cross point card/module and redundant controller/ logic cards to achieve complete (1+1) redundancy.
- (vi) The switcher should have auto-switchable redundant dual power supplies.
- (vii) A certificate from Compression OEM regarding compatibility with compression NMS is required to be submitted for the offered router along with the bid.

*Shimansh*

*lok*

*[Signature]*

- (viii) Any of the 64 HD-SDI and SD-SDI input shall be capable of being switched to any or all of 64 outputs ports.

**C) Technical Specification:**

Sl	Parameter	Specification
1.	Matrix size	64 x 64 for HD-SDI and SD-SDI port
2.	Input and connector	HD-SDI with embedded audio ( including Dolby AC-3 5.1 audio & Dolby E, SD-SDI with embedded audio and ASI (BNC/HD BNC; 75 ohms)
3.	Equalization for SD-SDI signal	Automatic: 150 Meters at 270 Mbps.
4.	Equalization for HD-SDI signal	Automatic: 80 Meters at 1.485 Gbps.
5.	Output and connector	One or more HD-SDI with embedded audio ( including Dolby AC-3 5.1 audio & Dolby E) and SD-SDI with embedded audio for each of 64 HD & SD SDI destinations; BNC/HD BNC; 75 ohm, 800 mV, ±10%.
6.	Return Loss	≥10 dB on data rate upto 1485 Mb/s throughout the switching chain.

**5.2.2 SDTV Encoder in MPEG-2 & H.264/MPEG-4-AVC Compression and HDTV Encoder in H.264/MPEG-4-AVC & H.265/HEVC Compression Configuration**

**A. Configuration of Encoding System:**

- (i) Bidder shall supply, install, test and commission (SITC) one set of compression system having H.264/MPEG-4 and H.265/HEVC compliant Encoders in (X+2) chassis configuration where "X" is no. of chassis comprising of atleast 16HDTV Encoders with SDI input per stream. "X" no. of these encoder chassis shall also be capable to take atleast 32 SDTV signal with SDI input and compress them to MPEG-2 and H.264/MPEG-4 compression format without any limitation or requiring upgradation /downgrading by way of hardware and software. Each encoder chassis shall have 4 to 8 BNC/HD BNC/Micro BNC/DIN/Mini DIN Female ports enabled for feeding SD/HD SDI input signal. Each encoder chassis should have same hardware and software licenses.

For example, if bidder offers encoder chassis with 8 BNC/ HD BNC/Micro BNC/DIN/Mini DIN Female port, the probable combination/configuration of channels to be compressed in each chassis are tabulated below:

Groups/ Combinations (at a time anyone)	No. of BNC/HD BNC /Mini DIN Ports enabled per chassis	No. of SDTV Channel to be compressed in MPEG-2 & H.264/MPEG-4 (at a time anyone)	No. of HDTV Channel to be compressed in H.264/MPEG-4 & H.265/HEVC (at a time anyone)	Total No of TV channels to be compressed in Each chassis

*Heimansh*

*for*

*for*

		standard) with SDI Input	standard) with SDI Input	
(a)	8	8	0	8
(b)	8	6	2	8
(c)	8	4	4	8

- (ii) All the above encoder chassis of compression system shall also be capable to take MPEG-2 TS over IP input with decoding of MPEG-2, H.264/MPEG-4-AVC and H.265/HEVC Main 10 compressed contents to base band signal format. All encoder chassis with MPEG-2 TS over IP input shall be capable to encode minimum 4 HDTV channel in H.264/MPEG-4-AVC & H.265/HEVC Main 10 (at a time anyone standard) and minimum 16 SDTV channel in MPEG-2 & H.264/MPEG-4 (at a time anyone standard) without any limitation or requiring upgradation/downgrading by way of hardware and software licenses.

The probable combination/configuration of channels to be compressed by enabling various filters (Noise Filters, Pre-processing, etc) are tabulated below:

Groups/ Combinations (at a time anyone)	No. of SDTV Channels to be compressed in MPEG-2 & H.264/ MPEG-4 (at a time anyone standard) with MPEG-2 TS over IP Input	No. of HDTV Channels to be compressed in H.264/MPEG-4 & H.265/HEVC (at a time anyone standard) with MPEG-2 TS over IP Input	Total No of TV channels to be compressed in each chassis
1	16	0	16
2	13	1	14
3	9	2	11
4	6	3	9
5	4	4	8

### B. Features of Encoder

- (i) There should be dual redundant SMPS power supply units per Chassis. In case of Single power supply unit in encoder chassis, bidders can offer additional chassis which shall be populated with same no. of encoders with single power supply unit for the completeness of the offer as an alternative to inbuilt redundant power supply unit.
- (ii) It should also have the preprocessing facility for the efficient encoding process viz; adaptive noise reduction.
- (iii) It should have multi-pass encoding.
- (iv) It should have interface for Remote Control.
- (v) It should generate PSI.
- (vi) On loss of Video input, it should have the option to auto switch to pre-recorded Image (JPEG/PNG, GIF format) and in case of "No video Input", it should be configurable to 'No video output'.
- (vii) The encoder shall be MPEG-2, MPEG-4 and HEVC standard compliant without any limitation or upgradation by way of hardware or software licenses.

*Guinness*

*lok*

*2*

- (viii) There should be provision for 4 stereo audio with MPEG-1 Layer-II & HE AAC v1 & v2 5.1 audio encoding in each SDTV encoder.
- (ix) There should be provision for 4 stereo audio with Dolby Digital (AC-3) 5.1 decoding & encoding, Dolby Digital plus 5.1 decoding & encoding, MPEG-1 Layer-II & HE AAC v1 & v2 5.1 audio encoding in each HDTV encoder which may enable to encode the audio in Dolby Digital (AC-3) 5.1 and Dolby Digital Plus 5.1 audio with down-mix of one MPEG-1 Layer-II at any given point of time.
- (x) There should be audio loudness control in each channel for maintaining uniform audio level in spite of changes from different input feeds and programs meeting the ITU-BS-1770-2/ ITU-BS-1770-3 standard for loudness control.
- (xi) The Encoder shall be closed captioning compliant with EIA 608/708, DVB-subtitling and digital program insertion compliant with SCTE35 insertion via SCTE104 triggers without any limitation or upgradation by way of hardware or software licenses.
- (xii) The encoded output of chassis should be MPEG-2 TS over IP on RJ45 connector.
- (xiii) Encoder hardware/Server shall also be capable to support RTMP, DASH, HLS encoding/streaming format, so that it may be enabled by additional licenses in future, if required.

### C. Serial Digital Interface (SDI) Input Specifications

Sl.	Parameter	Specification
1	Video Inputs	SD-SDI & HD-SDI with embedded audio
2	Serial Interface	i) SMPTE 292M, 1485 Mb/s (10 bit) with embedded audio ii) SMPTE 259M, 270 Mb/s (10 bit) with embedded audio
3	Format	ITU(R)-BT. 601 & ITU-R BT.709
4	Connector	BNC/HD BNC/Micro BNC/DIN/Mini DIN female, 75 ohm
5	Physical SDI Port enabled	i) Minimum 4 Port ii) Maximum 8 Port
6	Input Level	800 mV p-p nominal +/- 10%, SDI input
7	Return Loss	≥15 dB from 5 MHz to 1.5 GHz /OR ≥10 dB on data rate upto 1485 Mbps

### D. Embedded Serial Digital Audio Input Specifications

Sl.	Parameter	Specification
1	Serial interface	a) SMPTE 272M b) SMPTE 299M
2	Format	AES/EBU, 4 stereo channels
3	Connector	BNC/HD BNC/Micro BNC/DIN/Mini DIN Female,75 ohm

### E. IP Transport Stream Input Specifications

Sl.	Parameter	Specification
-----	-----------	---------------

*Jimarsh*

*Feb*

*[Signature]*



1	Type	Gigabit Ethernet
2	MPEG Format	MPEG 2 TS over IP (SPTS & MPTS)
3	Decoding of Video from TS	i) MPEG-2 ii) H.264/MPEG-4-AVC iii) H.265/HEVC Main 10
4	Decoding of Audio from TS	i) MPEG-1 Layer-II ii) HE AAC V1 & V2 5.1 Audio iii) Dolby Digital AC-3 5.1 Audio iv) Dolby Digital Plus 5.1 E-AC-3 Audio
5	No of Ports dedicated for IP Input source	Minimum two nos. independent ports and configurable in redundant mode
6	Port Speed	1000 Mbps or better per port
7	Ethernet Interface	1000 base T or better
8	Ethernet Connectors	RJ 45

#### F. IP Streaming Input Specifications

Each encoder chassis shall have the facility to pull the channel from Cloud/URL. Thereafter, channel may be decoded; and encoded in desired format for multiplexing with external IP Encapsulator cum Multiplexer. Input format of IP stream is given below:

1. RTMP IP Streaming Input Format of TV Service							
i) HDTV Channel							
Input Format	Stream-ing Format	Profile Number	Video Decodin-g standard	Profile	Video Resolutio-n	Audio Decoding Standard	Type of Audio channels
RTMP	MPEG TS i.e. (.TS)	1	H.264	High	1920 x 1080	AAC-LC,V1,V2	Stereo, Mono for AACLC,V1 and V2
		2	H.264	High	1440 x 1080	AAC-LC,V1,V2	Stereo, Mono for AACLC,V1 and V2
		3	H.264	High	1280x720	AAC-LC,V1,V2	Stereo, Mono for AACLC,V1 and V2
ii) SDTV Channel							
Input Format	Stream-ing Format	Profile Number	Video Decodin-g standard	Profile	Video Resolutio-n	Audio Decoding Standard	Type of Audio channels
RTMP	MPEG TS i.e. (.TS)	1	H.264	High	720 x 576	AAC-LC,V1,V2,	Stereo, Mono for AACLC,V1 and V2
		2	H.264	High	544 x 576	AAC-LC,V1,V2	Stereo, Mono for AACLC,V1 and V2

*Himanshu*

*Path*

*1*

							1 and V2
		3	H.264	High	480x576	AAC-LC, V1, V2	Stereo, Mono for AACLC, V1 and V2

## 2. HLS IP Streaming Input Format of TV Service

i) HDTV Channel							
Input format	Stream-ing Format	Profile Number	Video Decodin-g standard	Profile	Video Resolutio-n	Audio Decoding Standard	Type of Audio channels
HLS	MPEG TS i.e. (.TS)	1	H.264 & HEVC	High	1920 x 1080	AAC-LC, V1, V2, DD, DD+	Stereo, Mono for AACLC, V1 and V2 5.1 for DD & DD+
		2	H.264 & HEVC	High	1440 x 1080	AAC-LC, V1, V2, DD, DD+	Stereo, Mono for AACLC, V1 and V2 5.1 for DD & DD+
		3	H.264 & HEVC	High	1280x720	AAC-LC, V1, V2, DD, DD+	Stereo for AACLC, V1 and V2 5.1 for DD & DD+
ii) SDTV Channel							
Input Forma-t	Streami-ng Format	Profile Number	Video Decodin-g standard	Profile	Video Resolutio-n	Audio Decoding Standard	Type of Audio channel-s
HLS	MPEG TS i.e. (.TS)	1	H.264 & HEVC	High	720 x 576	AAC-LC, V1, V2, DD, DD+	Stereo, Mono for AACLC, V1 and V2 5.1 for DD & DD+
		2	H.264 & HEVC	High	544 x 576	AAC-LC, V1, V2, DD, DD+	Stereo, Mono for AACLC, V1 and V2 5.1 for

*Jimarshu C*

*Sub*

*3*

							DD & DD+
		3	H.264 & HEVC	High	480x576	AAC- LC, V1, V2, DD, DD+	Stereo, Mono for AACLC, V1 and V2 5.1 for DD & DD+

*Jimarsh**Feb**2*

3. SRT IP Streaming Input Format of TV Service							
i) HDTV Channel							
Input format	Streaming Format	Profile Number	Video Decoding standard	Profile	Video Resolution	Audio Decoding Standard	Type of Audio channels
SRT	MPEG TS i.e. (TS)	1	H.264 & HEVC	High	1920 x 1080	MPEG-1 L-II, AAC-LC, V1, V2, DD, DD+	Stereo, Mono for AACLC, V1 and V2 5.1 for DD & DD+
		2	H.264 & HEVC	High	1440 x 1080	MPEG-1 L-II, AAC-LC, V1, V2, DD, DD+	Stereo, Mono for AACLC, V1 and V2 5.1 for DD & DD+
		3	H.264 & HEVC	High	1280x720	MPEG-1 L-II, AAC-LC, V1, V2, DD, DD+	Stereo for AACLC, V1 and V2 5.1 for DD & DD+
ii) SDTV Channel							
Input Format	Streaming Format	Profile Number	Video Decoding standard	Profile	Video Resolution	Audio Decoding Standard	Type of Audio channels
SRT	MPEG TS i.e. (TS)	1	H.264 & HEVC	High	720 x 576	MPEG-1 L-II, AAC-LC, V1, V2, DD, DD+	Stereo, Mono for AACLC, V1 and V2 5.1 for DD & DD+
		2	H.264 & HEVC	High	544 x 576	MPEG-1 L-II, AAC-LC, V1, V2, DD, DD+	Stereo, Mono for AACLC, V1 and V2 5.1 for

*Handwritten signature*

*Handwritten mark*

*Handwritten mark*

							DD & DD+
		3	H.264 & HEVC	High	480x576	MPEG-1 L-II, AAC-LC, V1, V2 DD, DD+	Stereo, Mono for AACLC, V1 and V2 5.1 for DD & DD+

#### 4. ZIXI IP Streaming Input Format of TV Service

i) HDTV Channel							
Input format	Streaming Format	Profile Number	Video Decoding standard	Profile	Video Resolution	Audio Decoding Standard	Type of Audio channels
ZIXI	MPEG TS i.e. (.TS)	1	H.264 & HEVC	High	1920 x 1080	MPEG-1 L-II, AAC-LC, V1, V2, DD, DD+	Stereo, Mono for AACLC, V1 and V2 5.1 for DD & DD+
		2	H.264 & HEVC	High	1440 x 1080	MPEG-1 L-II, AAC-LC, V1, V2, DD, DD+	Stereo, Mono for AACLC, V1 and V2 5.1 for DD & DD+
		3	H.264 & HEVC	High	1280x720	MPEG-1 L-II, AAC-LC, V1, V2, DD, DD+	Stereo for AACLC, V1 and V2 5.1 for DD & DD+
ii) SDTV Channel							
Input Format	Streaming Format	Profile Number	Video Decoding standard	Profile	Video Resolution	Audio Decoding Standard	Type of Audio channels
ZIXI	MPEG TS i.e. (.TS)	1	H.264 & HEVC	High	720 x 576	MPEG-1 L-II, AAC-LC, V1, V2, DD, DD+	Stereo, Mono for AACLC, V1 and V2 5.1 for DD & DD+
		2	H.264 & HEVC	High	544 x 576	MPEG-1 L-II, AAC-LC, V1, V2, DD, DD+	Stereo, Mono for AACLC, V1 and V2 5.1 for DD & DD+
		3	H.264 & HEVC	High	480x576	MPEG-1	Stereo,

*Heimanshu*

*Salh*

*[Signature]*

			HEVC			L-II, AAC-LC, V1, V2, DD, DD+	Mono for AACLC, V1 and V2 5.1 for DD & DD+
--	--	--	------	--	--	-------------------------------	---

5. Input Format of Radio Service received through IP Streaming				
Input Format	Profile Number	Streaming Format	Audio Decoding Standard	Type of Audio channels
HLS	1	(i) MPEG TS i.e. (.TS) (ii) Raw audio format(.aac)	(i) AAC-LC, (ii) HE-AAC V1, (iii) HE-AAC-V2,	Stereo , Mono for AACLC, V1 and V2

Each Encoder chassis shall have the facility to encode minimum 8 Radio Service received through IP Input streaming.

### G. Video compression parameters

Sl.	Parameter	Specification
1	Video Resolutions (PAL)	For SDTV 720 x 576, 544 x 576, 480 x 576, For HDTV 1920 x 1080 1440 x 1080
2	Profiles and Levels	i) SD MPEG-2, MP@ML ii) SD H.264/MPEG-4, MP@L3 iii) HD H.264 Main Profile Level 4.0 iv) HD H.264 High Profile Level 4.0 v) HD H.265/HEVC Main 10
3	Video Bit-rate	i) 500 Kbps to 4 Mbit/s for 4:2:0 Profiles of SDTV on MPEG-2 depending on Resolution ii) 3 to 20 Mbit/s for 4:2:0 Profiles of HDTV in MPEG-4 depending upon Resolution iii) 3 to 8 Mbit/s for 4:2:0 Profiles of HDTV in HEVC Depending upon Resolution
4	Temporal Processing	I, B, B, P frames structure to support low delay mode.
5	Coding of Interlaced Video	Adaptive field & frame Processing support
6	Spatial Redundancy	Discrete Cosine Transform (DCT) Reduction
7	Chrominance Format	4:2:0
8	Aspect Ratio	4:3 and 16:9

*Shimansh*

*Sh*

*Sh*

9	Type of Encoding	Variable bit rate
---	------------------	-------------------

#### H. Audio Compression Parameters

Sl.	Parameter	Specification
1	Audio Encoding Method	i) MPEG-1 layer II ii) HE-AAC (MPEG-4) v1 & v2 5.1 Audio iii) Dolby Digital 5.1 AC-3 audio iv) Dolby Digital Plus 5.1 E-AC-3 audio
2	Data rate	i) 64-192 kbps (MPEG-1, layer II) ii) 32-72 kbps (HE AAC v1 encoding) iii) 16-64 Kbps (HE AAC v2 encoding) iv) 224-640 kbit/s (Dolby Digital 5.1 audio encoding) v) 192-640 kbit/s (Dolby Digital Plus 5.1 audio encoding)

#### I. IP Transport Stream Output Specification

Sl.	Parameter	Specification
1	Type	Gigabit Ethernet
2	MPEG Format	MPEG 2 TS over IP
3	No of Ports dedicated for IP Output	Minimum two nos. independent ports and configurable in redundant mode
4	Speed	1000 Mbps or better per port
5	Addressing	Unicast and Multi cast (at a time only one).
6	Ethernet Interface	1000 base T or better
7	Ethernet Connectors	RJ 45

#### J. Control and configuration of Encoder chassis

Sl.	Parameter	Specification
1	Control port	Min. 1 no. 10/100/1000 Base-T Ethernet port for NMS
2	Connector Type	RJ 45

#### K. Hardware of Server in case of software compression solution

##### a) General Feature:

- i. CPU/Chipset of server should have facility to enable an environment where applications can run within their own space, protected from all other software on the system.
- ii. CPU/Chipset of server should have security feature that can reduce exposure to viruses and malicious-code attacks and prevent harmful software from executing and propagating on the server or network.
- iii. CPU/Chipset of server should have facility of Secure Key consisting of a digital random number generator that creates truly random numbers to strengthen encryption algorithms.
- iv. CPU/Chipset of server should have Thermal Monitoring facility to protect the processor package and the system from thermal failure.
- v. The offered processor of server should be scalable, high quality, robust with efficient performance.

*J. J. J.*

*f.f.*

*f.f.*

- vi. Each server of software compression solution should be designed with 85 percent (Max.) CPU loading.
- vii. CPU of server shall be similar to Intel Xeon Gold series or better and launch date of CPU of server should not be prior to year 2021.
- viii. Facility to store the last configuration in the network hardware so that in case of failure of the Compression System Control Computer, the system remains running and continues to Statistically multiplex two or more programme as per the last good configuration.

**b) Hardware Feature:**

Sl.	Parameter	Specification
<b>A</b>	<b>Performance of Central Processing Unit</b>	
1	No. of Core	24 (Min) per CPU
2	No. of Thread	48( Min.) per CPU
3	Processor Base Frequency	2.60GHz or better
4	No. of CPU	One or more
<b>B</b>	<b>Memory Specification</b>	
5	RAM	DDR4, 64 GB or more
6	Storage Memory	SSD, 240GB (Min.) in RAID 1 Configuration
<b>C</b>	<b>Operating System</b>	
7	Operating system	Linux
<b>D</b>	<b>Ethernet Network</b>	
8	No. of Ports (Duplex) in Server	i) 2 Nos. of 1 Gigabit port for Input or more ii) 2 Nos. of 1 Gigabit port for Output or more iii) 2 nos. of 1 Gigabit port for Management & Control iv) 2 nos. of 1 Gigabit port for Ancillary services
<b>E</b>	<b>PCI slot</b>	
9	PCI slot for SDI	2 nos. or more
<b>F</b>	<b>Operating Environment</b>	
10	Operating Temperature	10 to +35 °C
11	Humidity	10% to 90% non-condensing

**5.2.3 IP Data Switch**

**A. Features**

- (i) Multicast IP routing and access control list of connected hardware
- (ii) Redundant swappable Power System for protection against power supply failures.
- (iii) IEEE 802.1/w Rapid reconfiguration of Spanning Tree, and IEEE802.1s Multiple VLAN instances of spanning Tree.
- (iv) IEEE 802.1x support for dynamic, port-based security, providing user authentication.

*Handwritten signature*

*Handwritten signature*

*Handwritten signature*



- (v) Real-time network fault analysis with easy-to-deploy device specific best-practice templates.
- (vi) The required hardware and software including their licenses shall be provided for Multicast IP Routing, VLAN configuration and GUI of the switch for configuration and Monitoring of IP ports through Compression NMS.
- (vii) The required Hardware & associated accessories (Cable with Connector) and software including their licenses shall be provided for stacking of the all IP Switches.

## B. Specification

Sl.	Parameter	Specification
<b>A</b>	<b>Performance</b>	
1	Forwarding rate	72 Mpps (100 MBps)
2	Memory:	
i	DRAM	4 GB (Min)
ii	FLASH	2 GB (Min)
3	Ethernet ports 10/100/1000 (Selectable)	48 (Min)
4	Switching capacity	176 Gbps(Min.)
5	Throughput	72 Mpps (Mega packets per second) or better
6	IPv6 support	in software
7	Uplink optics type	4 SFP (Min 10GB per SFP port)
8	CPU	800 MHz (Min)
9	Shared buffer	12 MB (Min)
10	Height of IP Switch	1 RU
<b>B</b>	<b>Indicators</b>	
11	Per-port status LEDs	link integrity, disabled, activity, speed, and full-duplex indications
12	System-status LEDs:	Fan, power and system Indicator

### 5.2.4 IP Encapsulator cum Multiplexer

#### A. Essential Features:

- i) Each IP Encapsulator cum multiplexer shall be capable of multiplexing minimum of 64 SDTV services or 20 HDTV services or combination of both SD & HD service + 4 Radio channels (only in CBR) with DVB-CSA (V-1 & V-2) supported DVB-CAS simulcrypt encryption through IP and ASI in CBR and/or VBR mode inputs per transport stream. It should have the facility for statistical Multiplexing, De-multiplexing and again multiplexing the relevant/required services.
- ii) The compression system (Either IP Encapsulator cum multiplexer or Encoder) should be able to create independent as well as combination of pool of services mux in statistical & CBR for MPEG 2, H.264/MPEG 4 and H.265/HEVC compressed streams of SD & HDTV channels.
- iii) Each IP Encapsulator shall have enabled minimum four independent IP data port (Bi-directional), one IP port for DVB-CSA (V-1 & V-2) supported DVB-CAS with simulcrypt encryption & four independent ASI input port and four independent ASI

*Shimavsh*

*Lok*

*1-2*

output port, so that IP Encapsulator shall be able to take input stream/signal through IP as well as ASI port for multiplexing the channels and take out multiplexed transport stream through IP on RJ 45 as well as ASI on BNC/HD BNC/Micro BNC port.

- iv) Each IP Encapsulator shall generate four independent ASI output transport stream with DVB-CSA (V-1 & V2) supported DVB-CAS simulcrypt Encryption(CAS) for transmission with option of generating ASI output transport stream without DVB-CAS encrypted (free to air) for monitoring of this set up.
- v) Each IP Encapsulator should be capable to multiplex both SDTV and HDTV signal simultaneously with DVB-CSA (V-1 & V-2) supported DVB-CAS simulcrypt encrypted ASI output as well as without DVB-CAS encrypted (free to air) independent ASI transport output for monitoring.
- vi) It should be possible to include any HD encoder part of any mux pool and transport stream irrespective of its physical location at IP switch and Route any service through any Input to any output.
- vii) There should be a facility to add minimum four numbers of configurable ASI port for implementation of DVB-CSA (V-1 & V2) compliant CAS system without any up-gradation by way of hardware and software in future.
- viii) IP Encapsulator should be capable to accept variable video bit rate Programme Stream and Multiplex the multiple streams in a multiple Multiplexing Group i.e. "n x services" and allocate optimum bit rate to the services in the Transport Stream.
- ix) The multiplexer shall be capable of transmission of broadcast data signals along with video and audio.
- x) IP Encapsulator should have DVB compliant for encapsulation of EPG data, DVB-SI/PSI table, NIT table, EMM table, ECM table generated by EPG and DVB-SI/PSI Generator/Server and CAS server in the output of transport streams.
- xi) Each IP Encapsulator cum Multiplexer unit should have Hot swappable dual redundant SMPS Power Supply.

## B. Technical Specification

Sl.	Parameter	Specification
a)	<b>IP data Port Specifications</b>	
1	Type	Gigabit Ethernet 802.3z
2	No. of Ports for input and output data	i) Minimum four nos. physical independent 1 Gigabit RJ45 ports (Bi-directional) with licenses (2 ports for Input & 2 ports for output configurable). ii) Minimum four nos. physical independent 10 Gigabits SFP port (Bi-directional) with SFP optical device cartridge.
3	I/O Speed	Min 900 Mbps per port
4	IP Encapsulation	MPEG -2 TS over IP
5	MPEG Format	188 B per TS

*Jimansh*

*ell*

*3*

6	Addressing	Unicast and Multicast (at a time only one).
7	Ethernet Interface	1000 base T
8	No. of Ports for ancillary data	Min. 2 Nos. physical 1 Gigabit RJ 45 port (Bi-directional)
9	Ethernet Control and Management connector	Min. 1 no RJ 45 for control and management
b)	<b>DVB-ASI Transport Stream Input Specifications</b>	
1	Format	MPEG-2 TS/ DVB-ASI
2	Quantity	Minimum 4 independent ports
3	Connector	BNC/HD BNC/Micro BNC; Female
c)	<b>DVB-ASI Transport Stream Output Specifications</b>	
1	Format	MPEG-2 TS/ DVB-ASI
2	Quantity (No. of o/p Port)	Minimum 4 Nos. (Two independent output ports for transmission and Two mirror output ports for monitoring).
3	Transport Stream output	100 Mbps per Output Stream
4	Connector	BNC/HD BNC/Micro BNC; Female

d)	<b>DVB-ASI Transport Stream Output Specifications</b>	
1	Format	MPEG-2 TS/ DVB-ASI
2	Quantity (No. of o/p Port)	Minimum Four Independent ports configurable to DVB-CSA (V-1 & V-2) encryption for transmission. These ports shall also be enabled to simulcrypt minimum two DVB-CAS encryption and configurable to free to air mode for monitoring.
3	Transport Stream output	100 Mbps per Output Stream
4	Connector	BNC/HD BNC/Micro BNC; Female
e)	<b>DVB-CSA ( V-1 &amp; V2) supported simulcrypt DVB-CAS Feature</b>	
1	IP Port for DVB-CSA V-1 & V-2 supported DVB-CAS Control with required licenses	Minimum one port (RJ-45)
2	No. of DVB-CAS to be simulcrypt	Minimum two CAS
3	Name of CAS to be deployed	Generic Conditional Access System (CAS)
4	IP data port for OTA with required license	Through IP data port or ASI input port
5	Scrambling Feature with required licenses	On all independent output port with each service and ON-Off facility.
6	EMM processing bandwidth	4 Mbps or better
7	ECM processing bandwidth	15 kbps or better per channel

*Jimarsh*

*lok*

*5*

### C. Statistical Multiplexing:

- (i) There should be Statistical Multiplexing software to enable Doordarshan to control the configurations of each channel encoder in order to optimize the bit rate used to encode the video material.
- (ii) The statistical Multiplexing shall essentially have following feature:-
  - a. User selectable minimum & maximum bit rates per channel.
  - b. Provision for linear bit rate changeover on frame by frame basis as per specified bit rate of each channel.
  - c. There shall be no break in service during change of bit rate of compression equipment and also during transition to redundant IP Encapsulator cum multiplexer. There shall be no requirement of rebooting of the compression equipment for effecting the change in configuration.
  - d. Real time bit rate management for continuous allocation of bandwidth between the encoders using only native hardware and software of encoders and multiplexer. That is without the use of any additional / external computer hardware or software
  - e. Stat Mux facility should support among all SDTV & HDTV channel with DVB-CSA (V-1 & V-2) supported simulcrypt DVB-CAS encryption (CAS).
  - f. Fast response to the variations as per the complicity of the source material.
  - g. Enabling of statistical Multiplexing shall not need any change in the hardware or software of the receiving equipment i.e. STBs.

### D. Implementation of DVB-CSA (V-1 & V-2) supported DVB-CAS, EPG, Video on Demand (VoD), NVoD, Subtitling, Audio descriptor, closed captioning etc.

Services like DVB-CSA (V1 & V-2) supported with simulcrypt DVB-CAS encryption (CAS), Subtitling, Audio descriptor, EPG etc will be carried by the DD free Dish DTH platform and the equipment offered by the bidder shall be capable of carrying these services without any limitation or requiring upgradation by way of hardware and software. *The offered* IP Encapsulator cum multiplexer shall also be Video on Demand (VoD) & NVoD with .TS format compliant, however Storage server, Play out system, GSM or IP based network for return path are not in the scope of this tender.

### 5.2.5 16x16 or better matrix SDI/ASI Routing Switcher

#### A. General:

The equipment should be very reliable and able to be used for selection of any one of the ASI/ SDI input signals to all destinations. The equipment so offered should be for professional Broadcast applications. The Router has to be quoted with X-Y and Single Bus control panels.

#### B. Essential Features:

- i. The routing switcher electronics should be capable of being mounted in a standard 19" rack frame.

*Shimansh*

*hsh*

*[Signature]*

- ii. The switcher shall handle SDI/ ASI signal for routing from input to output destinations. The switching should take place during the vertical interval period with re-clocking.
- iii. The switcher should have storage facilities for control information, so that in case of power supply failure, the status of the switcher output should remain unchanged when the power supply is restored.
- iv. The switcher should have a built in Auto-Switch able redundant dual power supply.
- v. The switcher quoted against this specification should be complete in all respects and should have the desired features.
- vi. A certificate from Compression OEM regarding compatibility with compression is required to be submitted alongwith the bid.
- vii. Any of the input shall be capable of being switched to any or all outputs of router.
- viii. Number of input and output port of ASI/SDI Router shall be same.

### C. Technical Specification:

Sl. No.	Parameter	Specification
1.	Matrix size	16x16 or better matrix
2.	Input	SDI/ASI ( BNC 75 ohms)
3.	Equalization	Automatic: 150 Meters at 270 Mbps.
4.	output	SDI/ASI (BNC 75 ohm)
5.	Return Loss	Should be maintained better than 15 dB on data rate up to 270 Mb/s throughout the switching chain.

## 5.2.6 Compression System Control Computer with Software

### A. Compression System Management Functions

- (a) The compression system control computer shall control the operation, redundancy switching and configuration of all parameters of encoders, IP Encapsulator cum multiplexers, SDI & ASI routers and IRDs including alarm and fault logs for a minimum of 365 days or configurable to 90/120/180 days subject to limitation of hard disk space.
- (b) NMS/AMS (Compression control system) offered should be capable to mux 60 TV channels (min) per mux group. However, there should not be any restriction on total number of output streams.
- (c) NMS/AMS of Compression system shall have the facility to configure, control and Monitor minimum 60 equipment/elements like IRDs, Encoders, IP Encapsulator cum Mux, SDI Router, ASI Router, RCPs, IP Switches etc.

### B. Salient Features:

The System Control Computer shall be used as a control protocol to configure the various parameters for the statistical multiplexing such as:

- i. To configure encoders for variable Bit Rate Transport Stream. Setting of minimum and maximum limits of data rate for each encoder.

*Jimarshu*

*folli*

*3*

- ii. To configure GOP pattern for frame-by-frame encoding. Encoding should take place at the encoder in real time.
- iii. If the System Control Computer fails or powered down, the whole system should be failure protected so that it still works.
- iv. Facility to store the last statistical Multiplex configuration in the network hardware so that in case of failure of the Compression System Control Computer, the system remains running and continues to statistically multiplex two or more program as per the last good configuration.
- v. To configure IRDs supplied by OEM to any pre-defined TV channels.
- vi. There shall also be a facility to configure the encoders for pre-defined Image (PNG/JPEG, GIF format) on the loss of video input in NMS.
- vii. There shall be facility to create ghost backup of hard disk of NMS computer on USB storage.
- viii. Each set of Network Management System (NMS) shall comprise of (1+1) rack mounted server for 24x7 operation in master and slave configuration or cluster configuration with three client licenses.
- ix. There shall be three client PCs with required licenses and 21 inch or better size display monitors along with each PC for monitoring of NMS system from remote locations.
- x. These client PCs shall be installed in the Monitoring room, shift in-charge room and HPA Portacabin room. HPA Portacabin room is located 30 meters away (approx.). An Ethernet connection required to be provided on the client PC for monitoring in HPA Porta-cabin room.
- xi. The Compression Control Computer (NMS) should be capable of controlling and monitoring all parameters of the digital video and audio compression system through suitable hardware interface and user friendly GUI.
- xii. To facilitate centralized network management operations in future, it should be possible to operate the system remotely via a suitably configured computer and modem over standard dial-up telephone lines or Broadband network. It should be supplied with complete hardware and software to interface all the equipment in the chain for their proper control and monitoring.
- xiii. The complete compression NMS software of each set is to be loaded on a single control computer/Server with networking facilities if offered in Master and slab mode, whereas compression NMS software of each set is to be loaded on two control computer/Server with networking facilities in cluster mode.

### C. Required Hardware and Software

The compression system control computer shall be based on industry standard, open system hardware and software that will provide a user-friendly GUI to the operator.

S. No.	Parameter	Specification
1	Man Machine Interface	Graphical User Interface (GUI)
2	Operational Features	Based on latest Windows / Linux version:

*Jimarsh*

*fat*

*5*

		(a) Diagnostic log (b) Transaction log (c) Password privilege system (d) Dial in modem support/Through Broadband (e) Multi user terminal support
3	Physical Connection to Equipment	Ethernet 10 Base-T/100 Base-T through CAT 6 or better cable
4	Hardware Platform	Supplier to provide full details of the industry standard hardware platform proposed
5	Software	Supplier to provide full details of the industry standard software platform proposed
6	Back up on USB storage	The back-up/ recovery USB storage for all the software are to be provided with proper licensees.
7	No of Equipment/ Element to be controlled by offered Compression NMS/AMS	75 Nos. (minimum)
8	Storage Memory	SSD, 240GB (Min.) in RAID 1 Configuration

#### D. Remote Access

It shall be possible to add a remote user terminal and modem/IP interface to provide access to the control system computer from a remote location via dial up telephone line/ Broadband network. The remote user shall have access to all the commands available at the main control system, subject to password restrictions for security. The remote user shall be presented with a user interface, which is identical to the local user interface.

#### 5.2.7 Network Time protocol (NTP) Server

##### A. General

- i. NTP server should be secured and reliable source of network time synchronization for broadcast application.
- ii. NTP Server shall have front panel display and keypad for configuration.
- iii. It should have Secure Web Interface for Configuration, monitoring of status, logs etc via Internet browser.
- iv. It should have dual redundant power supply.
- v. It should have also GPS based time synchronization facility consisting of necessary equipment and licenses.

##### B. Technical Specification

S.NO.	Description	Specs
1.	Accuracy (GPS Locked)	5 microseconds per day( $5.79 \times 10^{-11}$ )
2.	Type of Oscillator	Rubidium (Rb)
3.	Network Timing Service	i) NTP V2, V3, V4

*Glimanish*

*Full*

*✓*

		ii) SNTP V3, V4
4.	Number of clients/devices to be synchronized	Minimum 2000
5.	Mode of Operation	Unicast, Broadcast and Multicast
6.	Network Input output port	Minimum two no. Gb Ethernet (RJ-45)
7.	Management IP Protocol	IPv4/ IPv6 Compliant
8.	Antenna Connector	SMA/N-type/TNC
9.	Management Interface	RS-232 or 10/100/1000 Based-T Ethernet Port
10.	Status Indicator	LED/OLED based
11.	Size	19" rack mountable

### 5.3 IF System

The IF System consists of the following equipment:

- a) Satellite Modulator in (1+1) redundant configuration
- b) IF Redundancy switch.

#### 5.3.1 Satellite Modulator

##### A. Essential Features:

- i) The offered modulator should be compact, reliable and have state of the art technology.
- ii) It should provide IF output ( $70 \pm 18$  MHz) as per DVB-S and DVB-S2 standards' modulation schemes based on the user requirement.
- iii) It should have facility to perform pre-equalization/pre-correction to signal before feeding upconverter so that downlink signal is kept within 36 MHz BW of the transponder. This should not affect the operation of the existing IRDs (MPEG-2, MPEG-4, HEVC and DVB-S & DVB-S2 compliant).
- iv) The offered modulators should have front panel display. It should be possible to configure the modulators through front panel keys and through browser on remote computer.
- v) The offered modulators should be compliant to the ETSI 103 129 DVB Carrier ID (DVB-CID) requirement.
- vi) Modulators will be used in 1+1 redundant mode.
- vii) The redundancy of the offered modulators shall be controlled through the offered IF redundancy switch.
- viii) In case of failure of main/ redundant modulator, audio/visual alarm should be generated to indicate the failure of main/ redundant modulator
- ix) The offered Modulators should have facility to take ASI input through BNC port and MPEG2 TS over IP input through IP data port.

*Handwritten signature*

*Handwritten mark*

*Handwritten mark*



- x) All the requisite drivers, software and licenses required for meeting the DD specifications must necessarily be pre-loaded and configured by the OEM before supplying equipment to DD.

### B. Technical Specifications:

S. No.	Parameter	Specifications
<b>I. ASI Inputs</b>		
1	Compliance	DVB Document A010 rev. 1, May 1997: Section 4.4
2	Byte stuffing modes	Byte and single packet burst mode.
3	Connector	BNC
<b>II. IP Input Data Port {External IP to ASI converter is not acceptable.}</b>		
1	Input data format	MPEG-2 TS over IP
2	Ethernet interface	1000 base T
3	Ethernet Connector	1xRJ45
<b>III. Forward Error Correction and Modulation Scheme as per DVB-S standard</b>		
1	Multiplex Adaptation and Energy Dispersal	As per ETSI EN 300 421 (DVB-S)
2	Outer Coding	Reed-Solomon (204,188,T=8)
3	Interleaving Depth	12
4	Inner coding	QPSK : Convolution R=1/2, 2/3, 3 /4, 5/6 or 7/8
5	Spectrum Roll off factor	20%, 25 % and 35% selectable
6	Modulation	QPSK
7	Transmission rates	variable, 1.0 to 45.0 M symbol/s (min.)
<b>IV. Forward Error Correction and Modulation Scheme as per DVB-S2 standard</b>		
1	Multiplex Adaptation and Energy Dispersal	As per EN 302 307 (DVB-S2)
2	Modulation	QPSK, 8PSK
3	Modulation mode	Should be capable of emitting signals on the following mode 1. Backward compatible mode ( DVB-S/ DVB-S2 one at a time) 2. Constant Coding and Modulation mode (CCM)
4	Outer Coding	BCH

*Shimara*

*fall*

*13*

5	Inner coding	LDPC R= 1/2, 3/5, 2/3, 3/4, 4/5, 5/6, 8/9, 9/10 (for DVB-S2, QPSK), R= 3/5, 2/3, 3/4, 5/6, 8/9, 9/10 (for DVB-S2, 8PSK)
6	Spectrum Roll off factor	5%, 10%, 15%, 20%, 25% and 35% selectable
7	Transmission rates	Variable, 1.0 to 45 M symbol/sec (min.)
<b>V. IF output Interface Specifications</b>		
1	Output Frequency Range	70 +/- 18 MHz
2	Output Impedance	75 ohms unbalanced
3	Connector	BNC, female
4	Output Return Loss	15 dB (min.)
5	Output Level Range	-20 dBm to 0 dBm
6	Level Step Size	0.2 dB max.
7	Spurious Outputs	$\leq -55$ dBc/4 kHz at 0 dBm output power level in Band. or $\leq -60$ dBm outside Band
8	Synthesizer Phase Noise	Should meet the requirements of IESS-308
9	CW mode	Selectable
10	Noise floor (No/ C)	$< -120$ dBc/Hz
<b>VI. Internal 10 MHz clock &amp; Synchronization</b>		
1	Frequency stability with respect to temperature	$< +2.5$ ppm over 0°C to 50°C

### 5.3.2 IF Redundancy switch

IF redundancy switch would be used for the compression chain redundancy in 1+1 configuration for Modulators.

#### A) Essential Features:

- (i) The offered IF redundancy switch must be from the OEM of offered satellite modulator or endorsed/authorised by the OEM of offered satellite modulator to ensure compatibility of the offered IF redundancy switch with the offered modulator system.
- (ii) In case of failure of main / redundant chain, audio or visual alarm should be generated to indicate the failure of main/ redundant chain.
- (iii) The offered IF redundancy switch should have dual redundant power supplies.
- (iv) Facility for automatic, Manual and remote (through web interface) switching of the modulators should be available through the IF Switch.

*Jimensha*

*Feb*

*[Signature]*

- (v) The switch should have high reliability, robustness and should be of professional type.
- (vi) All the requisite drivers, software and licenses required for meeting the DD specifications must necessarily be pre-loaded and configured by the OEM before supplying equipment to DD.

### B) Technical Specifications

S. No.	Parameter	Specifications
i)	Operating frequency range	50 to 200 MHz
ii)	Insertion loss	≤ 3 dB
iii)	Isolation	
	a) Input to input	45dB min
	b) input to output	50dB min
iv)	Input return loss	13 dB min
v)	Output return loss	13 dB min
vi)	IF connector	BNC/ SMA type
vii)	Impedance	75 Ohms
viii)	Remote control	RS232 or RS422/485 or RJ 45

## 5.4 RF System

The RF Chain consists of the following equipment.

- a) C-Band Up-converter (U/C) in (1+1) redundant configuration.
- b) RF Redundancy Switch for U/C Redundancy (external or internal).
- c) 1:2 RF Splitter.
- d) 1:4 IF Splitter.
- e) HPA (C-Band, 1 k W) in (1+1) redundant configuration with RF waveguide switch and Dummy load.
- f) Semi Rigid Elliptical Waveguide
- g) Automatic waveguide Dehydrator

Output of IF Redundancy Switch will be connected to the input of Upconverters in 1+1 redundancy configuration through IF Splitter. Output of RF Redundancy Switch will be fed to the HPAs using RF Splitter.

### 5.4.1 C-Band Up-converter:

#### A. Essential Features:

- a) The offered RF Redundancy Switch (in case of external RF Redundancy Switch) must be from the OEM of the offered upconverter or endorsed/authorised by the OEM of offered upconverter to ensure compatibility of the offered RF redundancy switch with the offered upconverter.

- b) In case of failure of main Up-converter, the RF Redundancy Switch should be able to provide RF signal output from redundant Up-converter.
- c) In case of failure of main/redundant Up-converter, alarm should be generated to indicate the failure of main/ redundant Up-converter.
- d) If the offered C band Up-converters are having built in redundancy controller then the built in redundancy controller should meet the technical specification mentioned at clause no. 5.4.2.

#### B. Technical Specifications :

Sl. No.	Parameters	Specifications
(i)	Input Frequency	70 MHz $\pm$ 18 MHz
(ii)	Input Connector	BNC(F)
(iii)	Input Power	-20 dBm to 0 dBm
(iv)	Input return loss	18 dB minimum
(v)	Input Impedance	75 Ohms
(vi)	Frequency Steps Size	Synthesized 125 KHz
(vii)	Frequency Stability	$\pm 1 \times 10^{-8}$ over 0 to 50°C
(viii)	Output Frequency range	5.85 GHz to 6.425 GHz
(ix)	Output Bandwidth	$\pm 18$ MHz
(x)	Output Connector	N Type(F)/ SMA(F)
(xi)	Output Impedance	50 Ohms
(xii)	Output return loss	18 dB minimum
(xiii)	Output Power	+10 dBm (min.) at P1 dB
(xiv)	Gain	30 dB (min.)
(xv)	Third order intermodulation at 0 dBm	-45 dBc or better
(xvi)	Amplitude response/ Gain Flatness	$\pm 1.0$ dB per 36 MHz (Max)
(xvii)	Gain Adjustment step size	0.2 dB (Max)
(xviii)	Phase Noise	IESS308/309 compliant or better
(xix)	Spurious	-60 dBc at 0 dBm output carrier related or better -65 dBm Non carrier related or better
(xx)	Remote Control	RS232 or RS422/485 or RJ 45 or any other port. This should be connectable to LAN using required format converters.

#### 5.4.2 RF Redundancy Switch:

##### A. Essential Features:

- (i) Built-in RF Redundancy controller or external RF Redundancy switch for Up-converters in 1+1 redundant configuration.
- (ii) The offered RF Redundancy Switch (in case of external RF Redundancy Switch) must be from the OEM of the offered upconverter or endorsed by the OEM of offered upconverter to ensure compatibility of the offered RF redundancy switch with the offered upconverter.

*Handwritten signature*

*Handwritten signature*

*Handwritten signature*

- (iii) The switch should be able to accept alarm signal from both main and redundant Up-converter.
- (iv) In case of failure of main Up-converter, the RF Redundancy switch (In case of external RF Redundancy Switch) should be able to provide RF signal output from redundant Up-converter.
- (v) Facility for Automatic, Manual and Remote switching should be available.
- (vi) In case of failure of main / redundant Up-converter, alarm should be generated to indicate the failure of main/ redundant Up-converter.
- (vii) The switch should have high reliability and should be of professional type.

#### B. Technical Specifications:

Sr. No.	Parameters	Specifications
(i)	Operating Frequency Range	5.85 GHz to 6.425 GHz
(ii)	Insertion loss	≤ 0.5 dB
(iii)	Isolation	60 dB or better
(iv)	Input return loss	13 dB min
(v)	Output return loss	13 dB min
(vi)	RF Input/Output Connector	SMA/N-Type
(vii)	Impedance	50 Ohm
(viii)	Remote control	RS232 or RS422/485 or RJ 45 or any other port. This should be connectable to LAN using required format converters.

#### 5.4.3 1:2 RF Splitter/(2:1) Combiner:-

S. No.	Description	Specifications
(i)	Impedance	50 Ohm
(ii)	Connector	SMA
(iii)	Frequency	5.850 GHz to 6.425 GHz
(iv)	VSWR	1.3:1 or better
(v)	Isolation	15 dB or better
(vi)	Insertion loss	1 dB or better

#### 5.4.4 1:4 IF Splitter

S. No.	Description	Specifications
(i)	Impedance	75 Ohm
(ii)	Connector	BNC
(iii)	Frequency	50MHz to 90MHz
(iv)	VSWR	1.3:1 or better
(v)	Isolation	28 dB or better
(vi)	Insertion loss	1 dB or better

## 5.4.5 Specification of High Power Amplifier

### 5.4.5.1 Solid State Power Amplifier (SSPA) based C-Band Linear Power Amplifier

#### A. Essential Features:

- (i) The High Power Amplifier (SSPA HPA) is to be used for the final power amplification of the digital RF signal (wide band) in C-band (from 5.850 GHz to 6.425 GHz) that would be fed to the antenna system.
- (ii) These HPAs are required to be configured in (1:1) redundant system. It should be indoor type and 19" rack mountable.
- (iii) The amplification has to be carried out in two stages i.e. Solid State driver Amplifier and Solid State Power Amplifier.
- (iv) It should have control and monitoring hardware interface ports along with software, which can monitor as well as operate the HPA system from a remote computer.
- (v) It should have front panel display to monitor forward RF power, Reflected RF power or VSWR, Bias Voltage and Bias Current, Temperature.
- (vi) The offered HPAs should have the facility to protect the HPA in case of abnormal rise of temperature, high reflected power or VSWR, over voltage, over current etc, available in the amplifier and it's functioning.
- (vii) During the failure of the Main HPA, it should generate audible alarm and the Output is to be switched automatically to the Backup HPA. The system shall work in Manual Mode also.

#### B. Technical Specifications:

S. No.	Parameters	Specifications
1.	Type of amplifier	SSPA (Indoor type, rack mountable)
2.	Frequency Range	5.850 GHz to 6.425 GHz
3.	Bandwidth	Minimum 575.00 MHz
4.	Output RF Power at Amplifier Flange	1000 W Min. (60.00 dBm)
5.	Gain at rated power	70 dB (Min.)
6.	RF Level adjust range	0 - 20 dB
7.	Gain adjustment step size	0.1 dB
8.	Gain variation/Flatness	1 dB (max.) for 40 MHz (Any narrow band) 2 dB (max) for 575 MHz bandwidth
9.	Gain Variation vs. Temperature (0 to 50 °C)	± 1.0 dB max. over operating temperature range
10.	Gain Stability at constant temperature	± 0.25 dB/ 24 hrs. (Max.)
11.	Gain Slope per 40 MHz	± 0.3 dB/40 MHz (Max.)
12.	Input VSWR	1.30:1 (Max)

*Handwritten signature*

*Handwritten mark*

*Handwritten mark*

13.	Output VSWR	1.30:1 (Max)
14.	Load VSWR	1.7: 1 max operational; any value for operation without damage.
15.	Residual AM noise (Max.)	-50 dBc to 10 KHz -20(1.5+logf) dBc to 500 kHz -85 dBc above 500 kHz.
16.	Residual Phase Noise	-10 dB below IESS 308/309 compliant or better AC fundamental related – 50 dBc Sum of all spurs-47 dBc
17.	AM/PM conversion at rated output power	2.5 Degree/dB Max.
18.	Harmonic Output at rated output power	-60 dBc Max
19.	Spurious/Noise Power at rated output power	-65 dBc or better
20.	Intermodulation Distortion (Two-tone, 5 MHz spacing) at rated output power	-26 dBc of better
21.	Group delay (40 MHz band) (a) Linear (b) Parabolic (c) Ripple (peak to peak)	0.01 ns /MHz or better 0.005 ns /square MHz or better 1 ns or better
22.	Power consumption at rated o/p	5 KW Nominal.
23.	Power factor	0.90 or better
24.	Operating temp:	-0° C to + 50° C
25.	Relative humidity	5% to 95% non condensing
26.	Altitude	Should operate upto 10,000 Feet AMSL
27.	Cooling	Forced air
28.	RF Input Connector type & Impedance	N Type (F), 50 ohms
29.	RF Output Connector	CPR 137 F/G waveguide flange
30.	RF power monitor connectors	N Type (F), 50 ohms
31.	Remote monitoring Port	RS 232/422 or 485, RJ 45 Ethernet
32.	Fail over Switching	Auto and Manual
33.	Operating Voltage	230 V, 50Hz (Nominal)
34.	Front panel display	LCD/TFT/OLED

#### 5.4.5.2 Travelling Wave Tube (TWT) based C-Band Linear Power Amplifier

##### A. Essential Features:

- (i) The High Power Amplifier (TWTA HPA) is to be used for the final power amplification of the digital RF signal in C-band (from 5.850 GHz to 6.425 GHz) that would be fed to the antenna system.

- (ii) These HPAs are required to be configured in (1:1) redundant system. It should be indoor type and 19" rack mountable.
- (iii) The amplification has to be carried out in two stages i.e. Solid State Intermediate Pre-Amplifier (SSIPA) and Traveling Wave Tube Amplifier (TWTA).
- (iv) It should have integrated (internal) linearizer.
- (v) It should have control and monitoring hardware interface ports along with software, which can monitor as well as operate the HPA system from a remote computer.
- (vi) It should have front panel display to monitor forward RF power, Reflected RF Power or VSWR, Helix voltage & current, heater voltage, TWT Temperature.
- (vii) The offered HPAs should have the facility to protect the HPA in case abnormal rise of temperature, high reflected power or VSWR, over voltage, over current etc, available in the amplifier and it's functioning.
- (viii) During the failure of the Main HPA, it should generate audible alarm and the Output is to be switched automatically to the Backup HPA. The system shall work in Manual Mode also.

#### B. Technical Specifications:

S. No	Parameters	Specifications
1.	Type of amplifier	TWTA (Indoor type, rack mountable) with integrated (internal) linearizer
2.	Frequency range	5.850 GHz to 6.425 GHz
3.	Bandwidth	Minimum 575.00 MHz
4.	Output power at TWT (Peak Power)	2200 W Min.( 63.42 dBm)
5.	Output power at Amplifier Flange	1000 W Min.( 60.00 dBm)
6.	Gain (a) At rated power (b) At Small Signal	70 dB (Min.) 75 dB (Min.)
7.	RF level adjust range	0- 20 dB (Min)
8.	Gain variation	1.0 dB (max.) for 40 MHz (Any narrow band) 3.0 dB for 575 MHz bandwidth
9.	Gain Stability Over temp, constant drive	± 0.25 dB/ 24 hrs. (Max.)  ± 1.0 dB max. over operating temperature range
10.	Gain Slope	± 0.02 dB/MHz (Max.)
11.	Input VSWR	1.3: 1 max
12.	Output VSWR	1.3: 1 max
13.	Load VSWR	1.7: 1 max operational; any value for operation without damage.
14.	Residual AM noise (Max.)	-50 dBc to 10 KHz -20(1.5+logf) dBc to 500 kHz

*Jimensha*

*lsh*

*✓*



		-85 dBc above 500 kHz.
15.	Phase Noise (Max.)	10 dB below IESS 308/309 compliant or better AC fundamental related – 50 dBc Sum of all spurs-47 dBc
16.	AM/PM conversion at 6 dB below rated output power	2.5 Degree/dB Max.
17.	Harmonic Output	-60 dBc Max
18.	Spurious/Noise Power at rated output power	-150 dBW / 4 KHz (Max.) for Receive band -65 dBW / 4 KHz (Max.) for Transmit band
19.	Intermodulation	-24 dBc or better with two equal carriers at 4 dB Output Back Off (OBO) (with linearizer) -18 dBc or better with two equal carrier at 4 dB Output Back Off(OBO) (without linearizer)
20.	Group delay, maximum (a) Linear (b) Parabolic (c) Ripple (peak to peak)	0.01 ns /MHz (linear) over any 40 MHz band 0.005 ns /square MHz over any 40 MHz band 0.5 ns over any 40 MHz band
21.	Power consumption at rated o/p	5 KVA Typical.
22.	Power factor	0.90 Min
23.	Operating temp:	-10° C to + 50° C
24.	Relative humidity	95% non condensing
25.	Altitude	Should operate upto 10,000 Feet AMSL
26.	Cooling	Forced air
27.	RF Input connector	N type female
28.	RF Output connector	CPR 137 F/G waveguide flange
29.	RF power monitor connectors	N Type female
30.	Remote monitoring Port	RS 232/422 or 485, RJ 45 Ethernet
31.	Fail over Switching	Auto and Manual
32.	Operating Voltage	230 V AC (Nominal)
33.	Front panel display	LCD/TFT

#### 5.4.6 Semi Rigid Elliptical Waveguide

S. No.	Description	Requirement
i.	Conductor Material	Corrugated Copper
ii.	Operating Frequency Band	5.85 GHz - 6.425 GHz

*Shimash*

*Sh*

*3*

iii.	Jacket Material	PE
iv.	Weight	1.1 Kg/m (maximum)
v.	Cut-off frequency	3.65 GHz
vi.	VSWR	≤1.15 dB at full freq. range
vii.	Attenuation at 6 GHz	≤ 4.0 dB/100 m

#### 5.4.7 Automatic waveguide Dehydrator

##### Essential Features:

1. Maintenance free, Harsh Duty, Automatic waveguide Dehydrator to Provide Clean & Dry pressurized air to ensure signal quality of antenna Waveguide
2. Pressure level 1-5(min) PSI user configurable (adjustable output pressure)
3. Brushless dual-diaphragm and Oil-less compressor for long life includes a pressure regulator and air filter.
4. Remote monitoring and control by Ethernet RJ-45, RS-422/485, RS-232 and alarm relay outputs
5. Provisions for dry-contact alarms for Low pressure alarm (< 5psi) and excessive run time alarm.
6. Air reservoir to store dry compressed air.
7. Display allows for IP configuration and status monitoring with or without network connection
8. 19" Rack mountable.
9. Environmental Noise Level: < 70 dB(A)
10. Operating voltage 230 ±5% VAC,

#### 5.5 Monitoring System

The monitoring system has three parts:

##### A. Confidence level monitoring system

Confidence level monitoring system consists of:

- a) 17"(Nominal) LCD (TFT) SD & HD Colour Monitor
- b) 16 Channel Audio Video Monitor
- c) IRD with L-Band inputs
- d) IRD with ASI input and IP input
- e) 32x32 HD-SDIASI Router
- f) High Quality Digital Audio Ampli-speaker

##### B. Input and downlink monitoring system of TV channels

The input and downlink monitoring system of TV channel consists of:

- a) Multi Image Display System for TV & Radio Channels
- b) DVB-S & DVB-S2 demodulator
- c) 55" Professional LCD Display with Backlit LED
- d) 32 Channel Video Logger

*Himanshu*

*lsh*

*15*

### C. IF and RF Monitoring System (Pota-Cabin near U/L Antenna)

The IF and RF Monitoring System consists of:

- a) IRD (L Band, ASI Input)
- b) Up-converter (70 MHz to L-band)
- c) Test Loop Translator (TLT for C-band U/L to L-band)
- d) C Band downlink to L Band Down Converter
- e) 17"(Nominal) LCD (TFT) SD & HD Colour Monitor
- f) 16 Channel Audio Video Monitor
- g) 40/42" (Nominal) LCD/LED/OLED TV

The specifications of main equipment of monitoring systems are given below.

#### 5.5.1 Confidence Level monitoring system

##### 5.5.1.1 17 inch (Nominal) LCD (TFT) SD & HD Colour Monitor

###### A. ESSENTIAL FEATURES:

- i) The offered monitor should incorporate high intensity, high contrast wide screen 17 inch (Nominal), wide viewing angle LCD Panel to view stable images from various angles: both horizontally and vertically, with no reduction in picture contrast, brightness and colour saturation.
- ii) The LCD panel of the offered monitor should have resolutions of 1920 x 1080 pixels in 16:9 aspect ratio. The offered monitor should support 16:9 and 4:3 aspect ratios of the video signal. The monitor should also support 1920X1080/50I (HD) and 720X576/50I (SD) video formats.
- iii) LCD colour monitor should accept SD and HD SDI input (detected automatically).
- iv) The offered monitor should support embedded audio.
- v) The offered monitor should have 10-bit signal processing.
- vi) The monitor should have 1:1 pixel mapping to display the pictures in the original resolution (subject to the native resolution of the LCD panel) and aspect ratio of the input signal without any stretch and distortion.
- vii) It should be possible for the user to select the industry standard colour temperature through menu for matching colours and gradation of the monitor.
- viii) The LCD panel should be coated with Anti-Reflection protection layer to provide high transmission rate of the internal light source and to keep the reflection from ambient light to a minimum.
- ix) The monitor should have an external remote control capability via Ethernet, serial or similar interface.
- x) The monitor should be light weight, robust, compact and 19 inch rack mountable. It should have front panel controls to control the display parameters like brightness, contrast, colour saturation, audio etc.

###### B. Technical Specifications:

S.No.	Parameter	Specification
-------	-----------	---------------

*Handwritten signature*

*Handwritten mark*

*Handwritten mark*

1	Display Size	17 inch(Nominal) diagonally
2	Resolution	1920x1080 pixels or better
3	Colour reproduction	16 millions or better
4	Contrast ratio	300: 1 or better
5	Viewing Angle	150 degree (min.) in Horizontal 150 degree (min.) in Vertical
6	Brightness	250 cd / sq. m or better
7	Supported Aspect ratio	4:3 and 16:9
8	Video Input	HD & SD-SDI (BNC) x 2 or more
9	Audio input	Embedded Audio
10	Video Format	SD 720 x 576, 704 x 576, 544 x 576, 480 x 576, 352 x 576 1920X1080/50I (HD)

### 5.5.1.2 16 Channel Audio/ Video Monitor

#### A. Essential Features:

- Audio/Video Monitor is to be used for confidence level monitoring of transmission chain at various points. Output of 32x32 SD/SDI router will be fed to 16 Channel Audio/Video monitor.
- The offered Audio/Video monitor should have high resolution LCD screen and support 1920X1080/50I (HD-SDI) and 720X576/50I (SD-SDI) video formats.
- It should decode and display upto 16 channel multi format audio simultaneously like dolby Digital (AC-3) 5.1 audio, dolby digital plus 5.1 (E-AC-3) audio, AES/EBU stereo channel for monitoring and metering.
- The offered system should have multi channel audio bar graph and speakers and should not be overlaid on the video.
- It should be 19" rack mountable and have facility to monitor loudness and save minimum 5 preset configurations.

#### B. Technical Specification :

Sl.	Parameter	Specification
1	Video input format	a) SMPTE 259 M SD-SDI with embedded audio b) SMPTE 292 M HD-SDI with embedded audio
2	Embedded Audio on SDI	i)Dolby digital (AC-3) 5.1 audio, ii)Dolby digital plus 5.1(E-AC-3) audio iii) Dolby E iv)One Stereo AES/EBU
3	Video input quantity & type	2 nos., SD & HD-SDI input
4	Connector type	BNC, female
5	Audio input format	16 channel/ 8 stereo digital AES / EBU
6	AES and SDI termination	75 ohm unbalance
7	Level meter scaling	AES/EBU, VU



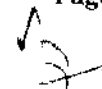

8	Level meter Parameter	Threshold, Reference, limits
9	Loudspeaker Power	12 W per speaker
10	Display Screen type & size	LCD , min 4 inch (diagonal)

#### 5.5.1.3 MPEG Decoder or IRD with L Band input for SDTV & HDTV

The specification remains the same as given in the para 5.1.2 of Technical Specification.

#### 5.5.1.4 MPEG Decoder or IRD with ASI & IP input for SDTV & HDTV

This IRD shall be provided with DVB-ASI & IP input card having MPEG-2 & H.264/MPEG-4 for SD-SDI with embedded audio, H.264/MPEG-4 & H.265/HEVC for HD-SDI with embedded audio and Dolby Digital 5.1 & Dolby Digital plus 5.1 audio decoder. The specification remains the same as given in the para 5.1.2, except the fact that RF Specification parameter specification 5.1.2(A)(i), 5.1.2(A)(v), 5.1.2(B) & 5.1.2(G), which are not applicable.

#### 5.5.1.5 32x32 HD-SDI/ASI Routing Switcher

##### A. General:

The equipment should be very reliable and able to be used for selection of any one of the 32 HD-SDI/ASI input signals to all destinations. The equipment so offered should be for professional Broadcast applications. The Router has to be quoted with X-Y and Single Bus control panels.

##### B. Essential Features:

- i. The routing switcher electronics should be capable of being mounted in a standard 19" rack frame.
- ii. The switcher shall handle HD-SDI/ ASI signal for routing from input to output destinations. The switching should take place during the vertical interval period with re-clocking.
- iii. The switcher should have storage facilities for control information, so that in case of power supply failure, the status of the switcher output should remain unchanged when the power supply is restored.
- iv. The switcher should have a built in Auto-Switch able redundant power supply.
- v. The switcher quoted against this specification should be complete in all respects and should have the desired features.
- vi. Any of the 32 input shall be capable of being switched to any or all of 32 outputs.

##### C. Technical Specification:

Sl. No.	Parameter	Specification
1.	Matrix size	32x32
2.	Input	32 nos. HD-SDI/ASI (BNC/HD BNC 75 ohms)
3.	Equalization	Automatic: 150 Meters of Belden 1694 or equivalent at 270 Mbps.
4.	Output	32 nos. HD-SDI/ASI (BNC 75 ohm)
5.	Return Loss	Should be maintained better than 15 dB up to 270 Mb/s throughout the switching chain.

*Jimersha*

*lkh*

*1*

### 5.5.1.6 High Quality Digital Audio Ampli-speaker

#### A. Essential Features:

- i) The offered ampli-speaker should have wide dynamic range, low distortion, flat frequency response and high SPL capability.
- ii) The offered ampli-speaker should have two way speaker system consisting of a woofer and a tweeter. It should be a bi-amplified active monitor system.
- iii) It should have 8" Low Frequency Transducer (woofer) and approximately 1" High Frequency Transducer (tweeter).
- iv) The transducers/ drivers should be magnetically shielded for exceptional transient response and superb power handling. There should be no interference when these ampli-speakers are placed in the close proximity of other audio and video equipment especially CRT-type monitors.
- v) It should incorporate two high power amplifiers to provide 150 Watts (RMS) or more power to the low frequency transducer and 70 Watts (RMS) or more power to the high frequency transducer. These amplifiers should be highly efficient and should withstand long hours of uses.
- vi) It should be equipped with a precise cross-over network for smooth transition between transducers.
- vii) The ampli-speaker should disperse sound across the frequency spectrum evenly and consistently along the horizontal and vertical window of consistency.
- viii) It should be possible to network multiple ampli-speakers to control their various parameters such as volume, equalizers/ filters etc. It should also be possible to calibrate various parameters of the ampli-speaker in accordance with the acoustic environment. Necessary hardware and software required for this purpose must also be included in the offer.
- ix) The ampli-speaker should have volume control arrangements for standalone operations. It should also indicate signal overloading.
- x) The ampli-speaker should employ Digital Signal Processing (DSP).
- xi) The offered ampli-speaker should accept balanced analog audio on 3-pin XLR female connector. It should also accept balanced AES/EBU digital audio input on 3-pin XLR female connector.
- xii) The offered ampli-speaker should be suitable for horizontal and vertical mounting.
- xiii) The offered ampli-speaker should also be capable of ceiling, wall and stand mountings.

#### B. Technical Specifications:

Sl. No.	PARAMETER	PERFORMANCE
1	<b>INPUTS</b>	
1.1	Digital Audio Input	AES/EBU, 24 bit, 48 kHz on XLR

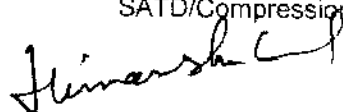



1.2	Analogue Audio Input	Balanced on XLR with 10K $\Omega$ input impedance
<b>2</b>	<b>DRIVERS</b>	
2.1	Bass (woofer)	8 inch
2.2	Treble (Tweeter)	approx. 1 inch
<b>3</b>	<b>FREQUENCY RESPONSE</b>	
3.1	Lower cutoff frequency	$\leq 43$ Hz
3.2	Upper Cutoff Frequency	$\geq 20$ KHz
<b>4</b>	<b>AMPLIFIER POWER</b>	
4.1	Bass (woofer)	150 Watts or better
4.2	Treble (tweeter)	70 Watts or better
4.3	Gain	X1, X5 and variable
<b>5</b>	<b>SOUND PRESSURE LEVEL</b>	
5.1	Short term RMS SPL @ 1 Meter	Better than 110 dB
5.2	Continuous Max SPL @ 1 Meter	Better than 100 dB
<b>6</b>	<b>DIMENSION</b>	
6.1	Width	$\leq 300$ mm
6.2	Height	$\leq 450$ mm
6.3	Depth	$\leq 400$ mm
<b>7</b>	<b>TOTAL WEIGHT</b>	
		$\leq 15$ Kg
<b>8</b>	<b>NETWORKING</b>	
		Via RJ 45 port

### 5.5.2 Input Source and Downlink monitoring system

- a. **Input source monitoring:** The input source monitoring of all the 32 SDTV channels including 16 HDTV channels of the transport stream will be done on Multi-image display system. All input signal will be available in MPEG-2, MPEG-4 & HEVC compressed MPEG-2 TS over IP transport stream format on RJ45. In addition to above, Input source monitoring of 4 Radio Channel compressed in MPEG-1 Layer-II will also be done on Multi-Image display system. These Radio channel will be available on MPEG-2 over IP transport stream.
- b. **Downlink signal monitoring:** The downlink signal monitoring of all the 32 SDTV channels including 16 HDTV channels of the transport stream will be done on Multi-image display system. The downlink signal will be required to demodulate and decode all services (32 SDTV channels including 16 HDTV channels and audio) from transport streams. The transport streams will be available in MPEG-2, MPEG-4 &

HEVC compressed MPEG-2 TS over IP format on RJ45. In addition to above, Downlink source monitoring of 4 Radio Channel compressed in MPEG-1 Layer-II will also be done on Multi-Image display system. These Radio channel will be available on MPEG-2 over IP transport stream.

- c. Other physical topography is acceptable provided it meets scope of work and project objective.

#### 5.5.2.1 Professional Broadcast Quality Multi Image display system for TV & Radio Channel

##### A. Essential Features:

- a) The Multi-viewer system is meant for monitoring the input sources and C Band DTH downlink signals.
- b) Each set of offered product shall be of professional broadcast quality & is able to display up to 32 or more videos simultaneously along with the corresponding audio bar graph keyed into the video.
- c) Two sets of complete monitoring systems are required to be provided. One set monitoring system shall be configured for monitoring of input sources (32 SDTV including 16 HDTV in each set) and another set of monitoring system for C Band downlink signals (32 SDTV including 16 HDTV in each set ) available in IP format of the transport stream compressed in MPEG-2, MPEG-4 & HEVC format. In addition to above, Input and Downlink source monitoring of 8 Radio Channel compressed in MPEG-1 Layer-II will also be done on Multi-Image display system. These Radio channel will be available on MPEG-2 over IP transport stream (Please see DRG: 4).
- d) The product shall facilitate selection of preset window layouts of various patterns and various sizes of video images.
- e) The system shall be flexible in terms of :
  - i) Control Multiple Screens
  - ii) Display the same source multiple times, in different sizes in the same or different modules.
  - iii) The system shall be capable of resizing the video signal and re-arranging the screen layout as per requirement
- f) It shall be possible to display real time analogue and digital clocks as a substitute for any input signal into a display window
- g) The offered product shall have the facility for labeling the displayed video source. The above features shall be selectable and removable depending upon the application
- h) It should support 4:3 and 16:9 aspect ratios and shall be able to configure for 4:3 or 16:9 aspect ratio instantly.
- i) It shall have SDI/DVI/XVGA/HDMI or better output to feed the combined video to display monitor.
- j) The video output of multi-viewer shall be matched with the video input of the 55" display system, if not then matching adapter may be included in offer.

*Finerish*

*for*

*3*



- k) The system should have one dedicated remote control panel (RCP) for easy, quick and user friendly access for recalling the required preset layouts, selecting full screen window, and selecting the audio source for monitoring etc. In case of software based RCP the required hardware should be provided in the offer.
- l) The offered product should have the interfacing facility to connect an external PC for video layout configuring.
- m) The bidder shall enclose the user list of the broadcasters to whom this product has been supplied.
- n) It should have hot swappable dual redundant power supply.
- o) It should have 19" rack mounted main frame;and it shall have the facility to accommodate modular cards to increase inputs, outputs and other interfacing facilities in case SDI Multiviewer or it shall have the facility to increase the inputs, outputs and other interfacing facilities by enabling additional licenses in case IP Multiviewer.
- p) It should have the facility to store/recall at least 10 nos. of preset layouts, window sizes etc.
- q) The offered solution shall be modular and expandable.
- r) The system shall provide High Video Quality with Excellent scaling, Full Frame rate. The system shall have scalability of Sources Display Devices.
- s) The system shall log actions taken in a secured file.
- t) The system shall provide customizable criteria for fault detection, alarm and reporting.
- u) The system/solution shall be able to detect and give (i) on screen alarms (ii) Audible alarms (like beep sound or tone) and (iii) log the following faults/errors :
- i) Loss of video.
  - ii) Frozen video.
  - iii) Black video.
  - iv) Loss of audio.
  - v) Audio level.
- v) There shall be a facility to add UMD for each and every input injected in the Video.

#### B. Technical Specifications:

S.No.	Parameter	Specification
1	Format of Input Transport Stream	MPEG 2 TS over IP (SPTS & MPTS)
2	SD-SDI Video Decoder	i) SD MPEG-2 ii) SD H.264/MPEG-4 AVC
3	SD-SDI Video Resolution	720 x 576 704 x 576 544 x 576
4	HD-SDI Video Decoder	i) HD H.264 Main Profile Level 4.0 8 bit ii) HD H.264 High Profile Level 4.0 iii) HD H.265/HEVC Main 10 Profile Level

*Shamsher*

*Path*

*13*

		4.0 10 bit
5	HD-SDI Video Resolution	1920 x 1080
6	Audio Decoder	i) MPEG-1 Layer-II ii) HE AAC V1 & V2 5.1 Audio iii) Dolby Digital AC-3 5.1 Audio iv) Dolby Digital Plus 5.1 E-AC-3 Audio
7	Video Output Format	SDI/DVI / XVGA/HDMI
8	Video Output Port	Min 2 nos. (Independent)
9	DVI Input Port	Min 1 No.
10	Operating Temperature	5 to 35 degree Centigrade
11	Humidity	8 – 90%

### 5.5.2.2 DVB-S & DVB-S2 Demodulator

The demodulators will be used in downlink monitoring chain. The chassis should consist of multiple modules. The module should essentially meet the following specs:-

S.No.	Parameters	Specification
<b>DVB-S Demodulator</b>		
1	Standards:	EN 300 421 (DVB-S)
2	Input Frequency Range	950 - 2150 MHz
3	No. of Inputs per module	1 or more independently tunable
4	Decoding	RS
5	Symbol Rates	1.0 to 40 M symbol/sec for (DVB-S)
6	FEC DVB-S	R= 1/2, 2/3, 3/4, 5/6, 7/8
7	LNB Signaling	LNB voltage + 22KHz continuous tone
8	LNB Voltage	0/13/18Volts
9	Connector:	F connector
10	Impedance:	75 ohms
11	Monitoring port	1 x ASI output on BNC or DVB-ASI over IP.
12	Management	10/100/1000 Base-T Ethernet
<b>DVB-S-2 Demodulator</b>		
1	Standards:	EN 302 307 (DVB-S2)
2	Input Frequency Range	950 - 2150 MHz
3	No. of Inputs per module	1 or more independently tunable
4	Decoding	LDPC and BCH
5	Symbol Rates	1.0 to 40 M symbol/sec for (DVB-S2)
6	FEC DVB-S2 QPSK	R= 1/2, 3/5, 2/3, 3/4, 4/5, 5/6, 8/9, 9/10
7	FEC DVB-S2 8PSK	R= 3/5, 2/3, 3/4, 5/6, 8/9, 9/10
8	LNB Signaling	LNB voltage + 22KHz continuous tone
9	LNB Voltage	0/13/18Volts
10	Connector:	F connector
11	Impedance:	75 ohms
12	Monitoring port	1 x ASI output on BNC or DVB-ASI over IP
13	Management	10/100/1000 Base-T Ethernet

### 5.5.2.3 Professional Broadcast 55" LCD Video wall Display

S.No	Parameter	Specifications
------	-----------	----------------

*Shivanshu*

*fell*

*2*

1	Size	55 inch or more
2	Backlit light	LED
3	Input	DVI, HDMI
4	Output	DVI
5	Resolution	1920x1080 or higher
6	Aspect ratio	16:9
7	Viewing angle	Horizontal: 170 degree, Vertical : 170 degree
8	Luminance	≥ 450 cd/m <sup>2</sup>
9	Contrast	1200:1
10	Bezel Size	Maximum 4.0 mm/4.0mm Bottom/Right) Maximum 4.0mm/4.0mm (Top/Left)
11	Power consumption	400W Max
12	Operation Hours	24x7 Industrial Type
13	Mounting	Wall and stand Mounting with mounting kit
14	Accessory	Power cord, DVI / HDMI Cable

#### 5.5.2.4 32 Channel Video Logger

##### A. General Features:

1. It shall be high-quality broadcast off-air recording system (TS logger, native transport stream), for 32 SDTV including 16 HDTV channel with four stereo audio. There shall be facility to record HDTV Channel with one stereo & 5.1 multi channel audio (Dolby digital 5.1 & HE-AAC 5.1 standard at a time any one).
2. It should be provisioned to record 32 SDTV including 16 HDTV channels through MPEG-2 TS over IP port demodulated & descrambled from 1 L band D/L frequencies signal. It should also be provisioned to record MPEG-2 TS through BNC port.
3. It should support Standard Definition video resolution broadcasts in MPEG-2 and MPEG-4 encoding and MPEG-1 layer-II (Mono and Stereo), HE-AAC for audio.
4. It should support High Definition video resolution broadcasts in MPEG-4 encoding for video and MPEG-1 layer-II (Mono and Stereo), Dolby digital plus 5.1, Dolby digital AC-3 (5.1), AAC and HE-AAC audio encoding.
5. The video logger should have multiple audio tracks support.
6. It should have the facility to record automatically the content 24x7 and archives it for minimum 90 days and assign metadata from associated EPG with real date & time stamp.
7. The video logger server shall be in N+1 Configuration for recoding and storage of 32 SDTV including 16 HDTV channels. Each sever shall record and store the content of SDTV, HDTV Channel in any one format at any given point of time. These servers shall be utilized to record and store HDTV channel without any up-gradation by way of hardware and software license. The number of HDTV channel shall be restricted to bit rate of audio and video signal defined in technical specification.
8. It should be an intelligent platform and web based broadcast logging solution.
9. It should be comply the media regulators requirements for DVB-Subtitle, closed caption, Loudness, DPI SCTE-35 etc

10. It should have the facility to Integrate BISS-1, BISS-E encryption, EPG, audio description etc.
11. It should have Quick access and retrieval of recorded content through web interface, GUI interface.
12. It should have facility to monitor content in live mode with logs and assign metadata to content.
13. It should have intuitive playback controls include slow-motion progress.
14. It should have facility for web application without any hardware and software upgradation.

#### **B. Transport Stream recording:**

1. It should have facility for transport stream monitoring (TS) that records the Transport Stream or selected programs from the Transport Stream.
2. It should have transport stream logging solution can record multiple MPTS/SPTS streams and record it in server with real time stamp.
3. Record multiple audio and multiple subtitles, DVB Teletext, Closed Captions, etc.
4. Exclude specific programs/PIDs or null packets from the Transport Stream.
5. Saving the TS in its original format (native) to monitor quality.

#### **C. Remote Broadcast Verification & Monitoring With Remote:**

1. It should detect problems — such as loss of audio or video signal, loudness deviation monitoring, frozen picture, etc.
2. Technical Monitoring will send a real time alert, allowing administrators to be aware and solve the problems immediately and optimize their transmissions.
3. It should be able to monitor :
  - i. Automated media performance monitoring
  - ii. Configurable, real-time alerts: SMTP, email, or SMS
  - iii. Daily logs for system administrators

#### **D. Technical Specification:**

S No.	Description	Requirement
1	Input/Ingest supporting Port	
a	MPEG-2 TS /DVB-ASI through BNC	2 Nos.
b	MPEG-2 TS over IP	2 Transport streams ( MPTS and SPTS)
2	Recording Bit Rate	
a	Video	256 Kbps to 10 Mbps
b	Audio	64 Kbps to 640 Kbps
3 a	Decompression of Video	a) MPEG-2, MPEG-4 compressed

*Jimarsh*

*lok*

*[Signature]*

		MPEG-2 TS over IP b) MPEG-2, MPEG-4 compressed MPEG-2 TS on BNC/HD BNC
b	Decompression of Audio	MPEG-1 Layer-II Dolby Digital 5.1, Dolby Digital Plus 5.1 audio and Dolby E
4	Storage Capacity for:	
a	SDTV channel with four Stereo Channels Video Bit Rate --512 Kbps (Min) Audio Bit Rate -- 64 Kbps (Min)	Minimum 90 Days in N+1 Configuration for 32 SDTV including 16 HDTV
b	HDTV Channel one Stereo Channels & 5.1 Multichannel audio (Dolby Digital 5.1 & HE- AAC 5.1 Standard at a time any one) Video Bit Rate --1 Mbps (Min) Audio Bit Rate --192 Kbps (Min)	
5	Recording Server	19" Rack mounted
6	Work Station for remote monitoring with required licenses	
a	CPU	Quad Core CPU or better
b	RAM	4 GB or more
c	Hard disk	250 GB or more
d	Network	Dual Ethernet Interface
e	Operating System	Windows (Windows 10 or better )
f	Management Port	100BASE-T Ethernet interface or better

### 5.5.3 IF and RF Monitoring System (Pota Cabin near U/L Antenna)

#### 5.5.3.1 MPEG Decoder or IRD with L Band input for SDTV & HDTV

The specification remains the same as given in the para 5.1.2 of Technical Specification)

#### 5.5.3.2 Up-converter (70 MHz to L-band)

*Seimensha*

*pell*

*13*

70 MHz to L-band Up-converter is to be used to check the monitoring output of modulators. Output of this Up-converter will be fed to IRD through RF Patch panel. The Specifications are detailed below:

S.No.	Parameter	Specifications
a)	Input Frequency	70 MHz $\pm$ 18 MHz
b)	Output Frequency range	950 MHz to 1450 MHz
c)	Input return loss	15 dB minimum
d)	Output return loss	15 dB minimum
e)	Phase Noise	IESS308/309 compliant
f)	Spurious	-55 dBc carrier related -65 dBm Non carrier related

#### 5.5.3.3 Test Loop Translator (TLT for C-band U/L to L-band)

Test Loop Translator (C-band uplink frequency to L-band) is to be used to check the monitoring output of Up-converters & HPAs. Monitoring ports of Up-converter and HPAs will be fed to TLT using a RF patch panel. Output of TLT will be fed to IRD (with L-band input) through patch panel. The Specifications are detailed below:

Sl.No.	Parameter	Specification
a)	Input Frequency	5.925 GHz to 6.425 GHz
b)	Output frequency	L-Band
c)	Conversion loss	Better than 20 dB+2 dB
d)	Level Control	25 dB Minimum
e)	Return loss (input)	15 dB or better
f)	Return loss(output)	15 dB or better
g)	Phase noise	IESS 308/309 Compliant

#### 5.5.3.4 C Band downlink to L Band Down Converter

S. No.	Description	Specifications
i.	Input Frequency Band	3.7 GHz to 4.2 GHz
ii.	Output Frequency Band	950 – 1450 MHz
iii.	RF Input Return Loss	18 dB minimum
iv.	Output Return Loss	15 dB minimum
v.	Noise Figure	20 dB maximum
vi.	Impedance	a. 50 Ohms input b) 50 Ohms output

*Heinrich C*

*lsh*

*✓*

vii.	Frequency stability	a) Daily $+5 \times 10^{-9}$ max b) Yearly $+1 \times 10^{-7}$ max c) $+2 \times 10^{-8}$ max over entire operating Temp.
viii.	Spurious	a) -60 dBm maximum (Non Carrier) b) -55 dBc maximum (Carrier)
ix.	Phase Noise	As per IESS 308/309 (phase noise profile)
x.	Output Power at P1dB	+5dBm minimum
xi.	Conversion Gain	20dB+1dB minimum
xii.	Gain Stability	+1.0 dB over temperature range
xiii.	Gain Flatness	$\pm 0.5$ dB across any 40 MHz at constant temperature
xiv.	Input Connector	N type
xv.	Output Connector	Suitable for terminating at F Type Patch panel

#### 5.5.3.5 17"(Nominal) LCD (TFT) SD & HD Colour Monitor

The specification remains the same as given in the para 5.1.1.1 of Technical Specification)

#### 5.5.3.6 16 Channel Audio Video Monitor

The specification remains the same as given in the para 5.1.1.2 of Technical Specification)

#### 5.5.3.7 40/42" (Nominal) LCD/LED/OLED TV Display Unit

S. No.	Features	Specifications for HD TV
1	Display Size	40/42" (Nominal)
2	Panel Technology	Inplane Switching (IPS)
3	Native Resolution	1920 x 1080 (HD)
4	Brightness	400 cd/ m <sup>2</sup> or above
5	Contrast Ratio (Dynamic)	450000:1 or better
6	Viewing Angle	178°x178°
7	Response Time	15 ms or less
8	Maximum Bezel Width (Left/Right/Top /Bottom)	13/13/13/20 mm or less
9	Input Ports	HDMI - 3 Nos., USB 2.0-1 no., RJ45-1 No., RF-1 No.
10	Output Ports	Optical output-1 for digital audio
11	Special features	Smart Share / Screen Share, Fail over, Wake on LAN, Wireless access point/Hotspot, Pre-loaded You-tube app, Play via URL, SOC Player
12	Wi-Fi	Built-in Wi-fi required
13	Bluetooth	Yes

*Shimansh*

*led*

*3*

14	Audio	20W (10W * 2)
15	Power Supply	100-240V~, 50/60Hz
16	Power Type	Built-In Power
17	Power Consumption	145 W or Less (Typical)
18	Certificates	BIS
19	Accessories	Table stand / Wall mount, Remote, IR remote, user manual
20	OEM Warranty	5 Years

## 5.6 Measuring Equipment

- a) Digital Waveform Monitor
- b) Spectrum Analyzer
- c) Portable handheld Ethernet tester

### 5.6.1 Digital Waveform Monitor (with Video & Audio measurement facility)

#### A. Essential Features

Waveform monitor is to be used for performance monitoring of Base Band signals i.e. audio and Video in digital mode for PAL format. This is to be used for SDI signal measurements. The essential features are:

1. The equipment shall be able to monitor SD digital video, SD-SDI along with digital audio (embedded or AES/EBU) and HD-SDI with Dolby digital (AC-3) 5.1 Audio Channel.
2. The equipment shall be able to provide total solution for SD-SDI and HD-SDI signal monitoring.
3. The equipment shall have dual input support.
4. The equipment shall have capabilities of carrying Waveform monitor & Vectorscope, Picture display, eye pattern diagram, SDI format analyzer, SDI jitter application etc.
5. The equipment shall have capabilities to display Parade and Overlay displays with interpolated waveforms.
6. The equipment shall have capabilities to numerical & Graphical display of AV delay.
7. The measuring equipment shall be able to take both vertical Interval and full field measurements.
8. The equipment shall have dual limit verification system employed to generate a caution or alarm system when either limit is violated.
9. It shall have Graphic display of Amplitude and timing measurement, linear and nonlinear distortion measurements.
10. The equipment shall have real time format analyzer with event logging and frame capture.
11. The equipment shall have fully remote control option facility.

*Himanshu*

*sdh*

*sdh*



12. The equipment shall have facility to interface with Video wall monitoring through DVI/HDMI/SDI or IP port.
13. The equipment shall have capabilities to measure loudness & true peaks as per ITU-R BS. 1770-2/ITU-R BS.1770-3 recommendations.

### B. Technical Specification

<b>i) SDI Input</b>			
1	Inputs	:	2; conforming to SMPTE 292M (HD-SDI: 1.485Gb/s) and SMPTE 259M (SD SDI: 270 Mb/s).
2	Input Connector	:	BNC 75Ω
3	Input level	:	800 mV p-p ± 10%
4	Return loss	:	≥ 15 dB (5 MHz to serial clock frequency)
<b>ii) SDI Output</b>			
1	Signal	:	Serially re-clocked output of the selected input signal
2	Output connector	:	BNC 75Ω
3	Output level	:	800 mV p-p ± 10%
4	Return loss	:	≥ 15 dB (5 MHz to serial clock frequency)
<b>iii) External Reference</b>			
1	Input signal	:	Tri-level sync signal or PAL black burst
2	Input Connector	:	BNC 75Ω
<b>iv) Waveform Vertical Characteristics</b>			
<b>1 Frequency Response- HD</b>			
(a)	Luminance Channel (Y)	:	≤ ±0.5 % (1 MHz to 30 MHz)
(b)	Chrominance Channel	:	≤ ±0.5 % (0.5 MHz to 15 MHz)
<b>2 Frequency Response- SD</b>			
(a)	Luminance Channel (Y)	:	≤ ±0.5 % (1 MHz to 5.75 MHz)
(b)	Chrominance Channel	:	≤ ±0.5 % (0.5 MHz to 2.75 MHz)
(c)	Amplitude Accuracy	:	≤ ±0.5 %
(d)	Gain	:	X1, X5 and variable
<b>v) Eye Pattern and Jitter Display</b>			
1	Type	:	Equivalent time sampler
2	Formats	:	HD/SD conforming to SMPTE 292M and SMPTE 259M

*Shimash*

*Sal*

*[Signature]*

3	Vertical Accuracy	Scale	:	800 mV $\pm$ 5 % (for 800 mV input)
4	Jitter filter		:	10 Hz, 1 KHz & 100 KHz
<b>vi)</b>	<b>Audio</b>			
1	Waveform Display		:	Lissajous display and surround display
2	Meter Display		:	Multi-channel Bargraph
3	Status Display		:	Dolby E metadata display
<b>vii)</b>	<b>Display</b>			
1	Screen type		:	LCD
2	Resolution		:	1024 x 768
3	Screen size		:	6.3" or better
4	Format		:	XGA

### 5.6.2 Spectrum Analyzer

#### A. Essential Features

- i) The instrument should be bench top, rack mounted model, AC operated and supplied complete with all accessories like input probes, Cables, Adapters and power cords, etc.
- ii) The instrument should have full set of marker functions including delta Marker, peak search marker, Zone marker, centre marker, multi marker (>6nos) and features like Spectrogram, Zoom/Zone Span.
- iii) The Instrument should have time and Data storage functions with internal memory to store minimum of 500 traces and 500 measurement setups.
- iv) The instrument should have remote control operation facility and should be programmable for automatic measurements with pre installed operating System preferably Windows.
- v) The instrument should have auto-calibration function.
- vi) The Spectrum Analyser should be capable of making following measurements and display results:
  - a) Noise power (in dBm / Hz or dBm/ Ch.)
  - b) C/N (in dBc/ Hz or dBc/ Ch.)
  - c) Occupied Band Width and Adjacent channel power
  - d) Average power of burst signal
  - e) Spurious Emission
  - f) Frequency Counter (min. resolution: 0.001Hz)
  - g) 2-tone, 3rd order intermodulation distortion
  - h) Power vs. Time, Frequency vs. Time, Phase vs. Time, CCDF, Amplitude Probability Distribution, Spectrogram
  - i) Spectral Emission Mask with Limit Lines

*Himanshu*

*Feb*

*7*

- j) Offered Spectrum Analyser should be able to analyse DVB-S(QPSK) , DVB-S2(8PSK) Modulations as used for satellite communication at Earth Stations. It should be able to provide following measurement trace modes for:

Constellation, EVM vs Symbol, Equalizer Amplitude, Equalizer Phase, Equalizer Group Delay, Equalizer Impulse Response, Custom Numeric, Magnitude Error vs Symbol, Phase Error vs Symbol, Frequency vs Symbol, Trellis, Eye Diagram, Numeric, I and Q vs Symbol, Magnitude vs Symbol, Phase vs Symbol, Signal Monitor, Symbol Table & others.

Software provided if any for the above measurements should be perpetual license with free upgrades during warranty period and for entire life time of the equipment

- vii) Spectrum Analyser should have superior XGA coloured LCD/TFT Display 8 inch or better.
- viii) The equipment should have internal (built-in) hardware and software for transfer of screen shot measurement data. USB & Ethernet/ LAN port should be provided for the remote control operation and connecting peripherals like Keyboard and printer or external PC/Laptop.

#### B) Technical Specifications:

<b>1</b>	<b>Frequency Range (DC coupled)</b>	9KHz to 26.5GHz or better
<b>a)</b>	Aging Rate	$\leq 1 \times 10^{-7}$ / year
<b>b)</b>	Temp, stability (5to 40deg.C)	$\leq \pm 5 \times 10^{-8}$
<b>c)</b>	Frequency span	0 Hz - (Zero Span), 1KHz to 26.5GHz or Better.
<b>2</b>	<b>Spectral Purity</b>	
<b>a)</b>	SSBPhase Noise @ 100KHz offset	-107 dBc/Hz @ 1GHz or better
<b>3</b>	<b>Bandwidths</b>	
<b>a)</b>	Resolution Bandwidth (3dB)	1Hz to 3MHz (3dB), in 1-3 sequence or (10% steps), 4, 5, 6, 8 MHz
<b>b)</b>	Video Bandwidths	1 Hz to 3MHz, in 1-3 Sequence or (10% steps). 4, 5, 6, 8 MHz
<b>c(i)</b>	Analysis Bandwidth	1KHz to 40MHz or better
<b>c(ii)</b>	Sampling Rate	50MHz or better
<b>4</b>	<b>Amplitude</b>	
<b>a)</b>	Max. Input level(continuous)	+30 dBm or better (Suitable external Attenuator can be provided to meet this requirement, if required.)
<b>b)</b>	Third Order Intercept Point	+12 dBm or better across specified frequency range

c)	Displayed average noise level at 0dB attenuation (RBW 10 Hz and 10 Hz VBW) at 25 GHz or Higher frequency	$\leq -134\text{dBm/Hz}$
d)	RF input attenuation range	0dB to 60 dB in 2 dB steps (manual or automatic).
e)	Input Connector/ impedance	N type/50 ohm
f)	Total Absolute Amplitude Accuracy	$\leq 1.0\text{dB}$ (Frequency @ 3GHz); $\leq 4\text{dB}$ @ 25GHz
5(a).	Sweep Trigger	Free run, Video, External
5(b).	Sweep Time	1ms to 1000 Sec( Span> 1KHz)
		$1\mu\text{S}$ to 1000 Sec (Span = 0Hz) or time domain mode
6	<b>Display</b>	
a.	Modes	Normal, Max/Positive Peak, Min./negative Peak, Average, RMS etc.
b.	Scales	Log Scales-dBmV, dB $\mu\text{V}$ , dB $\mu\text{V/m}$ , dBm,
		Linear Scale-V 1dB/div to 10dB/Div. in suitable steps.
7	<b>Interface</b>	Ethernet or LAN -RJ45 & USB port.
8	<b>Accessories</b>	a) Standard accessories including Low Loss Test Port extension Cable (Min. 1 mtr length with suitable connectors & adaptors (if required) ) to connect with the RF IN port of Spectrum Analyser should be supplied from OEM.
		Optional accessories shall be offered to complete all the measurement applications. Additional items to be offered if required b) Internal Memory 40 GB or Higher.

## 5.7 Power Supply System

The Power Supply System consists of the following equipment:-

- 75 KVA 3 Phase Isolation Transformer
- 75 KVA Oil Cooled Automatic Voltage Regulator (AVR)
- 2x60 KVA UPS operating in (1+1)parallel redundant load sharing mode with 15 minutes battery backup for each UPS

*Prakash*

*sdh*

*sdh*

- d. Power Distribution Panels (PDPs), Sub distribution Boards (SDBs) for power distribution to the various equipment chains and Mains Distribution Units (MDUs).
- e. Suitable earthing for the power supply system.

### 5.7.1 75 KVA air-cooled Isolation Transformer (To be used externally at input of AVR/UPS)

The Isolation Transformer should be Three Phase, naturally air-cooled type; housed in one steel cubical provided with cast iron wheels at bottom and should have Hooks for lifting the unit. The cubical enclosing the Isolation Transformer should have sufficient openings (doors and removable covers) for ease of operation and maintenance of the system.

Sl.	Parameter	Specification
1.	AC Input:	Delta 3-phase, 400 V $\pm$ 15% (phase to phase)
2.	AC output:	Star 3-phase, 400 V $\pm$ 15% (phase to phase) 230 V (phase to neutral)
3.	Frequency:	47 to 53 Hz
4.	Capacity:	75 KVA
5.	Duty cycle and use	24 x7 Continuous, Indoor
6.	Common Mode Noise Rejection	Better than 110 dB
7.	Inter winding capacitance	Less than 0.005 pF
8.	Load regulation	$\leq$ 4%
9.	Insulation resistance	More than 500 Mega Ohms at 500V
10.	Input & Output Terminals	Studs on fiber glass plate

### 5.7.2 Oil cooled Automatic Voltage Regulator (AVR)

The unit should be self-contained, compact, efficient and highly reliable for 100% duty cycle, 365 days a year and based on field proven design using modern technology.

Sl.	Parameter	Specification
1	Input Voltage Range	400 V $\pm$ 15%, 3 phase , 4 wire AC
2	Capacity	75 KVA
3	Output voltage and rated operating frequency	400V $\pm$ 1% three phase AC (230 V Phase to neutral) Voltage should be adjustable to $\pm$ 5% with control located on front panel
4	Voltage regulation	$\pm$ 1 % from no load to full load
5	Frequency	AVR should work satisfactorily with input frequency range of 48-52 Hz
6	AVR Type	Indoor, servo controlled
7	Speed of correction	20 volt per second or better
8	Metering	(i) Digital meters shall be provided with selector switches for measurement of phase to phase and Phase to neutral voltage on all three phases for input and output (ii) Digital ammeter in output on all three phases

*Simarsh*

*Lok*

*[Signature]*

		(iii) Indications , on control panel should be provided for input/ output voltage status
9	Electrical protection	Protection against overload, short circuit surge voltage due to system faults, switching operations and hotspot temperatures
10	Main selector switch	Four position heavy duty control switch shall be provided for the following operations (i) OFF- The input is cut off (ii) Test - Input is through but output is cut off (iii) ON- Input and output both are through (iv) By Pass- AVR gets isolated and input gets directly connected to output
11	Input output connection	Terminal for connection
12	Cooling	Oil-cooled
13	Manual control	Provision for manual control of each phase in case of failure of automatic controls system
14	Efficiency	90% or better

### 5.7.3 UPS system including Battery

Bidder will have to supply, install, test and commission the 2x60 KVA UPS including Battery System for Earth Station.

#### A. General Features of UPS:

The UPS should be reliable and stable in operation under Indian tropical conditions. It should have a front panel LCD display to show various parameters of the system to ease the monitoring. The UPS system shall be capable of running in single stand-alone Mode as well as in Parallel Redundant Load Sharing Mode with another identical UPS as per the attached configurations shown in DRG No. 6 & 7.

1	<ul style="list-style-type: none"> <li>a) The UPS system should be fully DSP controlled in all respects (i.e. rectifier control, inverter control, display, digital diagnostics), solid-state type, utilizing On Line Double Conversion technology (high frequency PWM using IGBT Rectifier &amp; inverter section).</li> <li>b) The UPS system should be capable of providing continuous high quality sinusoidal waveform power for electronic equipment loads.</li> <li>c) The UPS system should conform to voltage frequency independent technology.</li> </ul>
2	<p>The DSP based controller should have following characteristics:</p> <ul style="list-style-type: none"> <li>a) Diagnostic monitoring achieved by Fast Fourier Transform (FFT) of spectrum analysis.</li> <li>b) Adaptive control by having the speed to monitor and control the system concurrently.</li> <li>c) Real time generation of smooth, near optimal reference profiles and move trajectories.</li> </ul>

*Shivansh*

*Sh*

*Sh*

	d) Control power switching and inverters and generate high resolution outputs.
3	The UPS should offer low input current harmonics distortion (THDI), good regulation, excellent transient response and high stability.
4	<p>a) The UPS system should have a monitoring panel (LCD Based) with various types of fault alarms and metering functions including:</p> <ul style="list-style-type: none"> <li>(i) Output voltage, current &amp; frequency.</li> <li>(ii) Input voltage, current &amp; frequency.</li> <li>(iii) Bypass Voltage, Current &amp; frequency.</li> <li>(iv) Battery capacity, backup time left &amp; bad battery indication.</li> <li>(v) Temperature of System, Inverter section and Rectifier section.</li> </ul> <p>b) The UPS system should display RMS value of load current.</p> <p>c) The UPS system should generate aural and visual alarm for bad Battery condition.</p>
5	<p>a) The UPS system should have wide input voltage and input frequency tolerance as specified in Rectifier section.</p> <p>b) Transient Voltage Surge Suppressor (TVSS) should be provided at the input &amp; output of the UPS System.</p>
6	The system should have provision for controlling all the three phases individually, even in case of 100% unbalancing at the output with even 0% load on one phase.
7	UPS should be configured for parallel redundant operation. In case of failure of parallel operation, automatic and manual override for the system to work in 1+1 hot standby should be available as per suggestive single line diagram in DRG No. 6 & 7.
8	The UPS system should be capable of supplying energy to load from commercial mains without any break even in case of phase reversal at the input. It should also generate aural and visual alarm in such a case.
9	<p>a) The system should have provision for protection against</p> <ul style="list-style-type: none"> <li>i. Input under voltage</li> <li>ii. Input Over Voltage</li> <li>iii. Output Over Voltage</li> <li>iv. Output Over load</li> <li>v. Output short circuit</li> <li>vi. Battery under Voltage</li> <li>vii. Over temperature</li> <li>viii. DC Over current</li> </ul> <p>b) The system should generate aural and visual alarms for above-mentioned conditions.</p>

*Jeinavsh*

*folk*

*✓*

10	The system should have Controls as (i) Input Circuit Breaker (ii) Bypass Circuit Breaker (iii) Maintenance Bypass Switch (iv) Inverter ON / OFF Switch (v) Alarm acknowledge switch
11	a) The system should have facility to store the Logs of the events being monitored by monitoring system. b) The UPS system should have the capability to store a minimum of last 100 events. c) The UPS should have in – built digital fault diagnostic through stored events in UPS system.
12	(a) Bidder should specify the nos. & type of desired batteries, which shall be part of the system to be offered. The maintenance free-batteries VRLA type shall only be acceptable. The detailed technical specification of batteries with their working life is also to be specified and provided with the offer. (b) The firm should also provide battery changeover unit for battery banks so that any bank can be connected to any UPS system.
13	The battery charger should have provision of a) Monitoring battery temperature and accordingly adjusting the charging level to enhance the battery life. b) Programmable battery charging which can be programmed to enhance battery life.
14	The UPS system should have communication port RS 232/RS485/RS422 /RJ45 and should be compatible to integrate with control computer. Suitable software for monitoring & diagnostics etc. should be supplied.
15	The UPS system should be designed with forced air-cooling for proper ventilation. Acoustic noise level should be kept at minimum.
16	The UPS system output should be isolated from the DC circuit of the UPS.
17	The UPS System quoted must conform to the latest international standards of safety and EMC. In general, following standards should be met: - a) Safety: IEC 62040-1 / EN 50091-1 b) Emission and Immunity: IEC 62040-2, Class A / EN 50091-2 (Class A) c) Performance: IEC 62040 –3/ EN 50091 – 3 d) CE-Marked in accordance with EEC directives 73/23 “low voltage” and 89/336 “electromagnetic compatibility”
18	The UPS manufacturer must be ISO 9001-2000 certified company. A copy of the certificate should be enclosed with the offer.

## B. Operation Features and Technology of UPS

### 1. Technology:

The UPS shall be designed to operate as **true on-line, double conversion DSP**

*Shimash*

*fol*

*3*



controlled type UPS strictly as per the definition of IEC 62040-3 as follows:

<b>a) Normal Operation:</b>		
UPS inverter should continuously supply the critical AC load. The rectifier & charger should take power from the AC input source, convert it to suitable DC and supply to inverter as well as charge the Batteries on Automatic Float cum Boost Mode.		
<b>b) UPS Mains Failure:</b>		
Upon failure of AC input power, the critical AC load should continue to be supplied by the inverter, which should obtain power from the battery bank. There shall be no interruption in power to the critical load upon failure or restoration of AC input source (Mains/DG).		
<b>c) Upon Mains Restoration:</b>		
Upon restoration of AC input power, the Rectifier/Charger should automatically restart walk-in and gradually take-over the supply to inverter and charging to the battery.		
<b>d) Static Bypass:</b>		
Each UPS Module should have in-built 100% rated static Bypass Line. In two UPS Modules connected in Parallel redundant Current Sharing Mode, in the event of any fault in one UPS, the faulty UPS should isolate itself and the healthy UPS, which normally shares the load 50%, should take-over the full load. All the loads should be transferred to the Static Bypass Line of the UPS without any break if the input frequency is within 50 Hz and with a break below 20 milliseconds if the input frequency is beyond 50 Hz for the following conditions:		
i. If both the UPS fails simultaneously		
ii. If overload beyond 150% for 1 minute is faced by the UPS		
iii. If both UPS sense over temperature (i.e. inverter exceeding 85 Deg Celsius simultaneously).		
iv. If both the UPS inverters are put-off		
<b>e)</b>	MTBF of the System	Minimum 150000 Hrs.
<b>f)</b>	Capacity:	60 KVA at power factor 0.9( 54 KW)
<b>g)</b>	Overall Efficiency (From I/P to O/P of the UPS System)	>93% (for all loads from 50% to 100%)

## 2. Features of Rectifier Section of UPS

1.	Technology	DSP Controlled IGBT Rectifier to reduce the harmonics.
2.	Input	3-phase, 4-wire plus Ground
3.	Input Voltage	400 V nominal (+ 15%, - 15%)
4.	Input Frequency	47 - 53 Hz
5.	Input Power factor	> 0.99
6.	Input Current Harmonic Distortion (THDi)	≤ 3%
7.	Soft start (0-100%)	10 Sec minimum
8.	DC ripple voltage	< 1%

## 3. Features of Inverter of UPS:

1.	Technology	Fully DSP based IGBT/PWM Inverter
2.	Output Voltage	3-phase, 4-wire plus Ground

*Signature*

*Let*

*2*

	(a) Nominal:	400 V AC (nominal), 50Hz
3.	Output voltage regulation: a) 100% Balanced load b) 100% Unbalanced load c) Transient response (100% step loading) d) Recovery time to steady state ( $\pm 1\%$ )	$\leq \pm 1\%$ $\leq \pm 2\%$ $\leq 5\%$ $\leq 5$ msec.
4.	Output frequency regulation (b) Line Connection: a) Self Connection:	$\pm 1\%$ (meeting input frequency range of 47-53 Hz.) $\pm 0.05\%$ or better
5.	Output voltage Distortion: (at rated load)	$< 1\%$ linear load, $< 3\%$ non-linear load with 3:1 <b>crest factor</b>
6.	Audible noise level at 1 meter	74dBA maximum
7.	Overload capacity: (a) Inverter  (b) Bypass Mode	Upto 110% 10 min Upto 133% 1 min  Upto 110% continuously at rated current 110% to 150% 10 min $\geq 150\%$ 2 seconds
8.	Computer Interface:	RS 232 Interface or Ethernet
9.	<b>Note: Bidder should Specify the following Parameters for quoted UPS system</b> i) Total system losses at nominal load (with charged battery) ii) Size of LCD panel for monitoring should be 50 x 100 mm minimum	

#### 4. Battery bank and Battery of UPS System

The bidder should submit battery sizing calculation from UPS/Battery OEM justifying following points:		
<ul style="list-style-type: none"> <li>No. of Cells</li> <li>Capacity of Cell (Ah), (By considering the K factor, efficiency of system, Temperature correction factor, Ageing correction factor, etc.)</li> <li>DC bus voltage</li> <li>The minimum required area for battery installation should also be mentioned.</li> </ul>		
S. No	Parameter	Specification
1.	Battery Bank Capacity	Minimum 50000VAH (for each UPS)
2.	No. of Battery String	1 no. for each Battery Bank (one battery bank with each UPS)
3.	DC Voltage of the battery bank	Should be Minimum 360 V
4.	Type:	12V Maintenance Free Valve Regulated Lead Acid (VRLA) type.

*Himanshu*

*Full*

*[Signature]*

5.	Backup time:	Minimum 15 minutes (at the End of Life (EOL) of Battery) for 100 % load with each UPS system
6.	Charging Voltage	Float: 2.23-2.27 V per Cell at 27°C
7.	Cutoff Voltage	1.70-1.75 V per Cell (should be Selectable)
8.	Floating Voltage regulation between no load & full load.	2% or better.
9.	Codes and standards	The supplying battery manufacturer shall be ISO 9001/14001 certified. The battery design shall be of proven technology. The manufacturer shall have 5 years of field experience. ISO-9001/14001 Certificate Copy for 'VRLA Battery' must be attached with the offer.
10.	Design	All cells within the battery string shall be of the same manufacturer and model. The cells shall be "valve-regulated" (maintenance free) type.
11.	Life	4 years designed life at 27° C on full float.
12.	Life Cycling Characteristics	Each battery shall be designed to provide 1300 cycles at 30% depth of discharge (DOD) at 27° C and 600 cycles at 50% DOD at 27° C.
13.	Recharge Rate	The battery shall be capable of a 90% recharge within 12 hours
14.	Operating Temperature	The battery shall be capable of operating in temperature ranging from 0° C to +40° C.
15.	Gassing	No Special ventilation shall be required under normal operating conditions. No specialized "battery room" shall be required to house the battery unit.
16.	Battery Orientation	Battery shall have front or top accessible terminals with clear removable covers to facilitate visual inspections and allow ease of service.
17.	Self-Discharge	The battery shall have a maximum self-discharge rate of 0.5-1.0% per week at 27°C.
18.	Housing of Battery	The battery system should be installed & supplied with M S racks (Stand)
19.	Capacity Testing	Each battery shall be capacity tested at the manufacturing facility as per standard battery testing procedure. For each battery, battery performance tables and curves shall be submitted with the

*Shimash*

*Self*

*2*

		supply. The curve may be obtained by test or by calculation.
20.	Accessories	Each battery shall be furnished with the following accessories: 1. Each battery system shall include the necessary inter-cell and inter-module connectors and terminal plates. The connectors shall be lead-tin plated copper and shall include stainless steel hardware. 2. Assembly and connection drawings. 3. Each module shall include an easily removable transparent "snap on" safety shield to cover all connectors
21.	Recycling services	The manufacturer must provide worldwide recycling services to properly dispose of spent lead-acid batteries. These services must include proper instructions for the packaging, transportation, and beneficial recycling as required meeting E.P.A. guidelines (or other applicable agencies) for the safe handling of lead-acid batteries. Documentation of disposal must be provided.

#### 5.7.4 Power Distribution Panel (PDP) & Sub Distribution Board (SDB)

- i) **AVR Output PDP:** PDP shall have one incoming power supply controlled by 4 pole industrial MCCB and outgoing power supply to all connected PDP/UPS/Existing uplink antenna panel to meet the requirement of all supplied equipment, controlled by suitable industrial TPN MCBs with 30% spare capacity to connect additional SDBs in future. PDP shall have provision of digital Volt meter, CT based digital current meter, phase indicator and double earthing connection points. Successful bidder shall submit schematic diagram in advance before installation for approval.
- ii) **UPS Output PDP:** PDP shall have dual incoming power supply controlled by 4 pole industrial MCCBs (any one selectable at a time) and outgoing power supply to all connected SDBs to meet the requirement of all supplied equipment, controlled by suitable industrial TPN MCBs with 30% spare capacity to connect additional SDBs in future. PDP shall have provision of digital Volt meter, CT based digital current meter, phase indicator and double earthing connection points. Successful bidder shall submit schematic diagram in advance before installation for approval.
- iii) **Sub Distribution Board:** SDB shall have one incoming power supply controlled by 4 pole industrial MCB and outgoing power supply to all connected Racks to meet the requirement of all supplied equipment, controlled by suitable industrial MCBs with 30% spare capacity to connect additional load in future. PDP shall have provision of double earthing connection points.

*Himanshu*

*Sub*

*[Signature]*

Successful bidder shall submit schematic diagram in advance before installation for approval.

### 5.7.5 Mains Distribution Units (MDU)

- i) Every rack should have minimum one set of single phase auto change over switch along with two Mains Distribution units (MDUs). Each MDU shall have sequential delayed output start up, output status LED and IEC-3 pin for each equipment installed in the rack.
- ii) All Equipment which have dual power supply unit shall be connected directly from both MDUs

Sl. No.	Parameter	Specification
1	No. of fused outlets with IEC 3-Pin Connectors in each MDU	12 nos. or more
2	Primary Power Supply	220/240 V AC nominal, Single phase, (50 +/- 2 )Hz
3	Current (Max)	16 Amp

### 5.7.6 Earthing System

- a. Earth pits should consist of Copper Earth electrode (diameter 20 mm (min)), insulated copper strip/wire (75 Sq. MM (Min)), Chemical earth fill compound with fast discharge characteristics, water absorbing gel, perforated Hard HDPE pipe (diameter 40 mm (min)), funnel, water supply provision upto each earth pit (preferably from A/c condenser), 10 feet depth (min) and 1 feet diameter (min.). Earth pit should be prepared so that earth resistance is less than 1 ohms -typical depth of earth pit is 10 feet minimum. (Sample picture is enclosed at DRG No. 10)
- b. All earth pits shall be extended upto Earth terminals with insulated copper strip (75 Sq.mm (Min)) in their respective equipment room i.e. Power Supply room, Compression room and Porta-cabin. All equipment rack shall be directly connected to Earth Terminals with insulated multi strand copper wire (25 sq mm (Min)) with copper lugs at both ends. (Sample picture is enclosed at DRG No. 12)

## 6 Physical, Environmental and Mechanical Specifications

### 6.1 Power Supply :

Equipment shall operate from a wide range of power supply voltages without interruption or damage.

### 6.2 Environmental Specifications (wherever not mentioned)

Sl.	Parameter	Specification
1	Operating Temperature (Indoor)	5°C to 35°C
2	Operating Temperature (Outdoor)	-10°C to 50°C
3	Storage Temperature	-10°C to 60°C
4	Humidity (Indoor)	5 to 85% non-condensing
5	Humidity (Outdoor)	10 to 95%
6	Altitude	2 to 1000 m

*Jimersh*

*Self*

*[Signature]*

### 6.3 Mechanical Specifications

Sl.	Parameter	Specification
1	Construction	Modular approach, EIA RS-310C, 19" rack mount
2	Cooling	Internal circulation fan wherever applicable
3	Mounting	Equipment shall be rack mounted and required number of racks shall be supplied pre-wired to house all the supplied equipment.

## 7 COMPLEMENT OF EQUIPMENT:

- a) The make and model/part no. of each and every equipment/item/installation material etc. should be clearly mentioned in the offered Bill of Material (BOM).
- b) The suggestive Bill of Material (BOM) has been provided in **Annexure-I of Appendix-D**. The bidder is required to provide the complete list of equipment, software and accessories etc. offered to meet the requirement as per DD specifications. The quantity of each item including sub-module, licenses etc. are to be specified clearly and compulsorily, failing which the bid is liable to be rejected summarily. The following is the proforma for the BOM:

Sr. No.	Description of the item as per specification (suggestive BOM)	Description of items offered by bidder	Quantity as per suggestive BOM	Quantity offered by the Bidder	Make Offered	Model Offered
1.	2.	3.	4.	5.	6.	7.

- c) The bidder should provide the offered un-priced Bill of Material in electronic form with the priced bid for ease of technical evaluation.

## 8 GENERAL

### 8.1 Compliance and OEM Authorisation

- a) Bidder must submit a point-by-point compliance statement in respect of all the points, sub-points and Paras laid down in this specification from page 1 in the format as indicated below along with bid.

Sr. No. of DD specs.	DD specs.	Compliance (Yes/No)	Performance fig. of equipment offered.	Deviations, in case of non-compliance	Optional items if any required to make the system Compliant to DD specs.	Features in the system offered Which exceed DD specs.	Page No.	Remarks

*Heimanshu*

*Full*

*✓*

1	----							
2	----							
3	----							

- b) In addition to the above, compliance from respective OEMs (not from their Indian representatives) in respect of the equipment as listed below should necessarily be given, in respect of all the points, sub-points and paras laid down in the Technical Specification of the respective equipment in the format as given above. The OEM should necessarily record the performance figure of the equipment offered in the quote for which the compliance statement is required.

<b>A</b>	<b>Input and Base Band System</b>
1.	L Band Router
2.	Integrated Receiver Decoders (IRDs)
3.	64x64 SDI Router
<b>B</b>	<b>Digital Compression System</b>
1.	Encoder
2.	IP Encapsulator cum Multiplexer
3.	16x16 ASI Router
4.	Data Switch
5.	Network Management System (NMS)
6.	NTP Server
<b>C</b>	<b>Satellite Modulator</b>
1.	Digital satellite Modulator
2.	IF Redundancy Switch
<b>D</b>	<b>RF System</b>
1.	C Band Up convertor
2.	RF Redundancy Switch
3.	High Power Amplifier (HPA)
4.	Waveguide
5.	Waveguide Switch
6.	Automatic Waveguide Dehydrator
<b>C</b>	<b>Monitoring system</b>
1.	70 to L Band Up Converter
2.	C Band Uplink to L Band Converter (TLT)
3.	C Band Downlink to L Band Converter

*Simarsh*

*Subh*

*3*

4.	17 inch (nominal) TFT Monitor
5.	16 Channel Audio/Video Monitor
6.	40/42" LED TV
7.	32x32 SDI Router
8.	Multi viewer
9.	Demodulator
10.	Professional Broadcast 55"(nominal)LCD (LED/OLED) Video Wall Display
11.	32 Channel Video logger
12.	Work Station for Multi viewer
13.	Control Computer for IF and RF System
<b>D</b>	<b>Measuring Equipment</b>
1.	Waveform Monitor (WFM)
2.	Spectrum Analyser
3.	Portable handheld Ethernet tester
<b>E</b>	<b>Power Supply System</b>
1.	Isolation Transformer
2.	AVR
3.	UPS system including Battery Bank

- c) Mere signature on a copy of Doordarshan specifications shall not be accepted as a compliance statement.
- d) The compliance statement in respect of Technical Specifications of the equipment should be supported by highlighted record of these in the relevant technical literature/data sheets of respective equipment enclosed with the tender and a clear reference (with volume number and page number of tender documents) to the attached supporting document should be given in the remarks column against each & every specs. Any offer without proper supporting document of each & every specs and containing only a commercial hand out/pamphlet is liable to be rejected.
- e) Data sheets in respect of all offered equipment should be submitted. Any deviation from the specification detailed in the compliance statement is to be highlighted separately. Page no. of location of data sheet should be given in page no. column of the compliance statement.
- f) Offers without proper & duly completed compliance statement are likely to be rejected with the sole responsibility of bidder and no further claim/correspondence will be entertained.
- g) The bidder is also required to submit authorization in respect of the equipment as listed above at Sl. No. 8.1(b) in their favour from respective OEMs (not from their

*Shimsha*

*fdh*

*[Signature]*



Indian representatives) on their letter heads along with the bid **as prescribed in Annexure II of Appendix-D.**

## 8.2 Documentation:

- a) One set of technical manual for all the equipment are to be provided along with the tender to facilitate the technical evaluation, otherwise the tender is liable to be ignored.
- b) The successful bidder will have to supply set of printed technical & user manuals along with factory test report of all the offered equipment.
- c) Operation Manual for all equipment should also be supplied on DVD/USB with search facility.
- d) All offered software should have perpetual validity and should be in the name of Doordarshan. All software backups should also be supplied on DVD/USBs.
- e) For facilitating maintenance issues, the bidder must submit the firm's self certified copies of Bill of Entry/Bill of Laden/Custom Invoice of all imported items to DG:DD.
- f) The successful bidder must ensure that all Invoices bear serial numbers of equipment to meet the requirement of WPC.

## 8.3 Guarantee/Warranty and After Sales Support:

The Guarantee, warranty of material and workmanship will be covered by General Terms and Conditions (GTC) at APPENDIX-B of the Bid document except the following:

- a) All the offered equipment shall be guaranteed against any manufacturing defect for a period of **5 (Five)** years from the date of Commissioning.
- b) Any part failing during the guarantee period shall be repaired/replaced free of charge by the successful bidder at site. For repairing of any defective equipment during guarantee period, the defective module or equipment requiring repairs will be handed over to local office/local authorized representative/ dealer who will arrange repairs locally at site or send/export the defective modules to OEM factory and re-import/send back after repairs.
- c) It is the responsibility of local office/ Authorized representative/ dealer of the bidder to arrange the repair/ replacement of faulty items for Doordarshan i.e. no transportation charges would be paid by DD for transporting the defective/ repaired items, if required to be removed from site, during the guarantee period.
- d) Guarantee period of Equipment or spare parts thereof replaced is to be extended corresponding to the outage period from the date of acceptance, if the failure rectification takes more than 30 days time.
- e) If bidder is not the OEM, then the guarantee/ warrantee in respect of the equipment as mentioned in Clause 8.1(b) shall be provided by the bidder through respective OEMs. **A certificate, duly signed by the OEM on the OEM letterhead, in this regard of the respective equipment must be submitted with the offer by the bidder as prescribed in Annexure III of Appendix-D.**

*Handwritten signature*

*Handwritten initials*

*Handwritten signature*

- f) If bidder is not the OEM, then after sales service support for additional **2 (Two) years** for the repairs/ maintenance in respect of the equipment as mentioned in Clause 8.1(b) after the completion of guarantee/ warranty period shall also be provided by the OEM either directly or through his representative in India. **A certificate, duly signed by the OEM on the OEM letterhead, in this regard of the respective equipment must be submitted with the offer by the bidder as prescribed in Annexure IV of Appendix-D.**

#### 8.4 Inspection and Commissioning:

The inspection of material will be carried out by the authority specified in the Purchase order. The material will be accepted only after the same has been found satisfactory after inspection and duly marked and sealed by the Inspection Authority. In addition to "General Terms and Conditions" (GTC) at Appendix-B of the Bid document, the inspection of material/equipment will be carried out as follows:

- 8.4.1** All the equipment to be supplied against this A/T (Purchase Order) for this tender shall be subjected to pre-installation inspection at Doordarshan Site by Doordarshan Officer appointed by Doordarshan Directorate. The pre-installation inspection shall be based on manufacturer's factory test results and physical verification of make and model of equipment. The successful bidder should produce the factory test reports of the offered equipment to facilitate inspection.
- 8.4.2** Post installation inspection and commissioning of the system will be carried out by a team of Doordarshan Officers authorized by Doordarshan Directorate and based on approved Acceptance Test Procedure (ATP).
- 8.4.3** A draft copy of ATP (Acceptance Test Procedure) must be submitted by the successful bidder one month in advance of the proposed date of inspection of the installed system to Doordarshan Directorate for approval. ATP should describe the standard test procedure of individual equipment and overall system. The factory test report will not be treated as ATP.
- 8.4.4** The approved ATP with or without changes shall be sent back to the successful bidder to be used for inspection and commissioning of the installed system by DD Engineer(s) at site. All the equipment required for the inspection as per the approved ATP are to be provided by the successful bidder.
- 8.4.5** The SITC certificate will be issued by the team of Officers appointed at S.N. 8.4.2 above

#### 8.5 Delivery Period:

Six months from the date of issue of purchase order (A/T) by Doordarshan to the successful bidder.

*Signature*

*Signature*

*Signature*

### 8.6 Pre-Bid Conference:

- a) A pre bid conference on technical Specifications and other issues shall be held on date and time specified in the NIT. All prospective bidders may attend the pre bid conference to discuss their queries and suggestions.
- b) All the queries and suggestions should be sent to Doordarshan at least 2 days before the date of pre bid conference. No queries/ suggestions shall be entertained after pre bid conference.
- c) Amendments subsequent to the pre bid conference shall be sent to prospective bidders, who have purchased tender document by e-mail/fax/post/uploaded on website.
- d) It shall be bidder's responsibility to check for any amendments/addendum on the website before submitting their duly completed bids.

### 8.7 Check List and Enclosures:

The bidders may ensure the following check list while submitting the bid including some important list of enclosures for ease of technical evaluation (**Annexure V of Appendix-D**).

- a) Whether documents related to fulfilment of the eligibility criteria as per Clause 3 have been submitted.
- b) Whether the BOM has been submitted in the prescribed format as given in Clause 6.
- c) Ensure that all equipment and accessories as given in Annexure-1 have been included in the offered BOM.
- d) Whether the compliance statement from the bidder as required in Clause 8.1 (a) has been submitted.
- e) Whether the compliance statements from the respective OEMs for equipment/system mentioned in Clause 8.1 (b) have been included.
- f) Whether the Authorization as required vide clause no. 8.1(g) in respect of equipment as mentioned in Clause 8.1 (b) from respective OEMs have been included.
- g) Ensure that the relevant technical brochures/manuals containing all the parameters of technical specifications of all the offered equipment and accessories have been included with proper indexing for ease of identification.
- h) Whether the page numbers of the relevant enclosed technical data sheet/manual against each parameter of the technical specifications have been given in the compliance statements.
- i) Whether the requisite undertakings for guarantee/warranty and after sales support by OEMs as required vide Clause no. 8.3 have been submitted.
- j) Ensure that no alternate item has been offered.
- k) Ensure that the Un-priced BOM has been included.
- l) Any other item mentioned elsewhere in the tender.

*Doordarshan*

*fell*

*✓*

**OEM LETTER HEAD**

**CERTIFICATE FOR AUTHORIZATION**

Date:

Tender No. :

We, M/s ..... (Name and Address of the OEM), do hereby authorize M/s..... (Bidder's name),having its office at ..... (Bidder's address) to submit the bid and sign the contract with Doordarshan for the products offered by us against the above tender.

Signature .....

Name & Designation of authorized signatory.....

Name of the OEM - .....

Stamp

*Jeinavsh*

*Feb*

*[Signature]*

**OEM LETTER HEAD****CERTIFICATE FOR GUARANTEE/WARRANTY**

Date:

Tender No. :

We, M/s ..... (Name and address of the OEM), do hereby confirm that:

1. All the offered equipment shall be guaranteed against any defect for a period of **5 (FIVE)** years from the date of Commissioning.
2. Any part failing during the Guarantee/Warranty period shall be repaired/replaced free of charge by the successful bidder at site. For repairing of any defective equipment during Guarantee/Warranty period, the defective module or equipment requiring repairs will be handed over to local office/local authorized representative/ dealer who will arrange repairs locally at site or send/export the defective modules to OEM factory and re-import/send back after repairs.
3. It is the responsibility of M/s -----,( their local office/ Authorized representative/ dealer of the bidder) to arrange the repair/ replacement of faulty items for Doordarshan i.e. no transportation charges would be paid by DD for transporting the defective/ repaired items, if required to be removed from site, during the Guarantee/Warranty period.
4. Guarantee/Warranty period of Equipment or spare parts thereof replaced is to be extended corresponding to the outage period from the date of acceptance, if the failure rectification takes more than 30 days time.
5. All software being offered, are to be licensed to Doordarshan on perpetual basis without specifying any time limit or without specifying end of life of the software. Software upgrades within Guarantee/Warranty period will have to be supplied free of cost.

Signature .....

Name &amp; Designation of authorized signatory.....

Name of the OEM- .....

Stamp

*Guinness**Lab**[Handwritten mark]*

## Annexure IV of Appendix-D

<b>OEM LETTER HEAD</b>
------------------------

**CERTIFICATE FOR AFTER SALES SERVICE SUPPORT**

Date:

Tender No. :

We, M/s ..... (Name and address of the OEM), do hereby confirm that after sales service support for additional **Two (2) years** for the repairs/maintenance of offered products after the completion of **Five (5) Years** guarantee/ warrantee period shall be provided through our representatives/authorized dealer/service provider for the offered equipment and accessories in India as mentioned below:

S. No.	Name of the authorized person	Name & Address of authorized After Sales & Support Office/Firm	Telephone/ Fax	Email of concerned personnel
1				

Signature .....

Name &amp; Designation of authorized signatory.....

Name of the OEM- .....

Stamp

*Jimensha*

*Red*

*✓*

## Annexure V of Appendix-D

<b>BIDDER LETTER HEAD</b>
---------------------------

**DECLARATION BY THE BIDDER**

1. Bill of Material (BOM)- : [Yes/No]
2. Bidder's compliance (As per specs clause no. 8.1.(a)) : [Yes/No]
3. The copy of Dealer Possession License in case of possession of RF equipment ( if applicable) : [Yes/No]
4. Copy of the Memorandum of Understanding (MOU) of Consortium/Joint Venture (If Applicable) (as per clause no. 3.9) : [Yes/No]
5. OEM Compliance for following equipment from their respective OEMs (as per clause no. 8.1.(b)):

S. No.	Name of equipment	Name of OEM	OEM compliance submitted (Yes/ No)
i			
ii			
.			
.			

6. Certificate for Authorization for following equipment from their respective OEMs:

S.No.	Name of equipment	Name of OEM	Authorization certificate submitted ( Yes/ No)
i.			
ii.			
iii.			
.			
.			

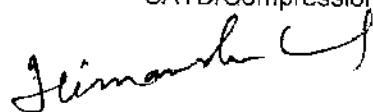



7. Certificate for Guarantee/Warranty for following equipment from their respective OEMs:

S.No	Name of equipment	Name of OEM	Guarantee certificate submitted (Yes/ No)
i.			
ii.			
iii.			
.			
.			
.			

8. Certificate for After sales service support for following equipment from their respective OEMs:

S.No.	Name of equipment	Name of OEM	After sales service support certificate submitted ( Yes/ No)
i.			
ii.			
iii.			
.			
.			
.			

9. Datasheet for the offered equipment as per offered BOM: [Yes/No]

- i.
- ii.
- iii.

Signature .....

Name & Designation of authorized signatory.....

Name of the Bidder - .....

Stamp

*Signature*

*Signature*

*Signature*



## Annexure VI of Appendix-D

<b>BIDDER'S LETTER HEAD</b>
-----------------------------

**CERTIFICATE FOR WORK EXPERIENCE**

**Date:**

**Tender No. :**

We, M/s ..... <Name and address of the bidder>, do hereby confirm that details of Work Experience are as follows:

S. No	Description of Work Experience of the Bidder	Details of Work Order No. with date	Copy of Work Order upload ed with bid (YES/NO)	Sr. No. of work/item of the uploaded work order to be considered for work experience of the bidder	Amount /Value in Rupees of the work to be considered for work experience of the bidder	Bidder's Work Experience Category (Please select anyone option i.e. (a)One work of 80% or (b)Two work of 60% or (c)Three work of 40% of Estimated Cost)
1						
2						
3						

Signature .....

Name & Designation of authorized signatory of the Bidder.....

Name of the Bidder.....

Stamp of the Bidder

*Signature*

*Signature*

*Signature*

## Annexure VIII of Appendix-D

**LIST OF TOOLS**

S. No.	Tools	Qty.
(1)	Soldering and de-soldering station	1 Set
(2)	T-Handle Hex Allen Keys Set	1 Set
(3)	Flat & Star Head Screw driver Set	1 Set
(4)	Flat & Star watch maker Screw Driver Set	1 Set
(5)	Flat Plier	1 No.
(6)	Nose Plier	1 No.
(7)	Edge Cutter	2 No.
(8)	Wire Stripper	1 No.
(9)	Crimping Tool for RG11 and RG59U Cable	1 No.
(10)	Crimping Tool for RJ11 and RJ45 Cable	1 No.
(11)	BNC Puller	1 No.
(12)	Crimping Tool for Power Cable	1 Set
(13)	Box Spanner Set	1 Set
(14)	D-Spanner Set	1 Set
(15)	Ring Spanner Set	1 Set
(16)	Adjustable Wrench	1 No.
(17)	File Set	1 Set
(18)	Handheld Magnifying Glass	1 No.
(19)	Toolkit Box (Hard case type)	1 No.
(20)	Battery operated multifunctional (screw, unscrew, drilling etc.) hand machine with battery charger and other accessories.	1 Set
(21)	Digital Multimeter	1 No.
(22)	Digital clamp-on Meter	1 No.
(23)	Handheld Ethernet tester	1 No.
(23)	Any other special tool required as per offered equipment	1 Set

*Shimash*

*Feb*

*23*

**Suggestive Block Schematic for SITC of Upgradation of Compression, Monitoring, RF and Power Supply System at Earth Station Pitampura - (Input Base Band System)**

Annexure VII of Appendix-D (DRG No. 1 to 13)

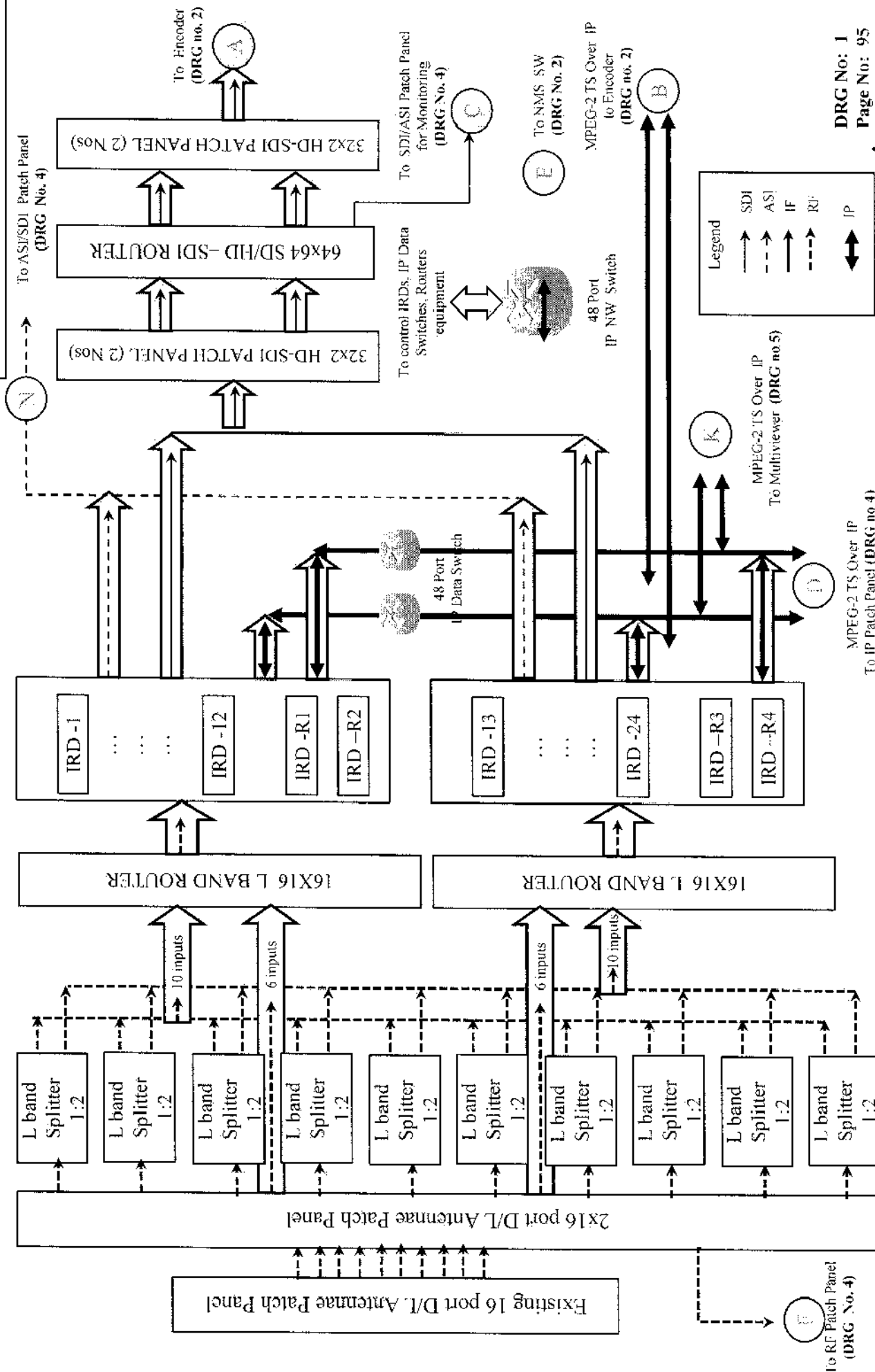

DRG No: 1  
Page No: 95

MPEG-2 TS Over IP  
To IP Patch Panel (DRG no 4)

*for*

*Shinwar*

# Suggestive Block Schematic for SITC of Upgradation of Compression, Monitoring, RF and Power Supply System at Earth Station Pitampura – (Compression System)

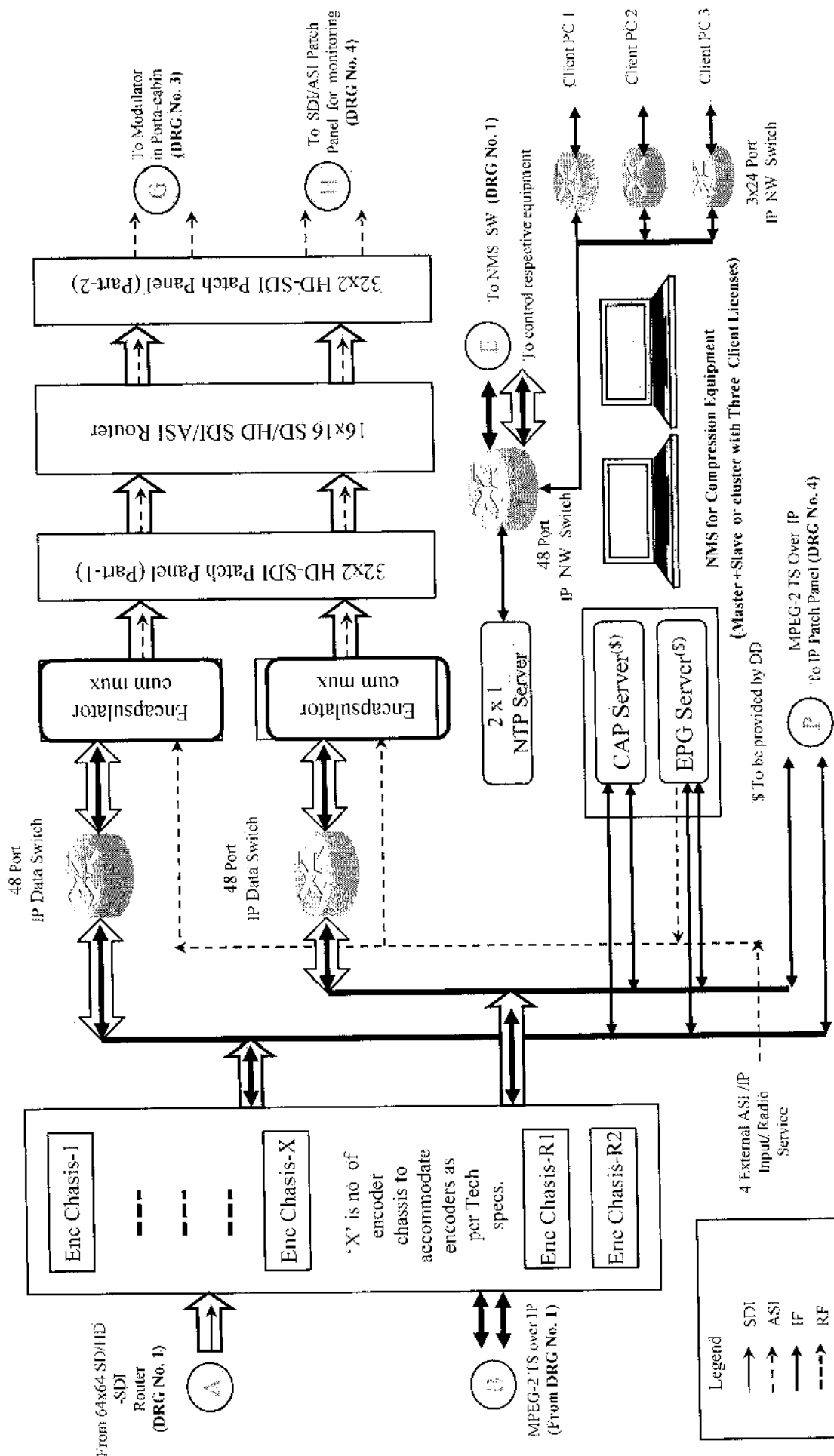

*Handwritten signature/initials*

*Handwritten signature/initials*

*Handwritten signature/initials*

# Suggestive Block Schematic for SITC of Upgradation of Compression, Monitoring, RF and Power Supply System at Earth Station Pitampura – (IF and RF System in Porta-Cabin near U/L Antenna)

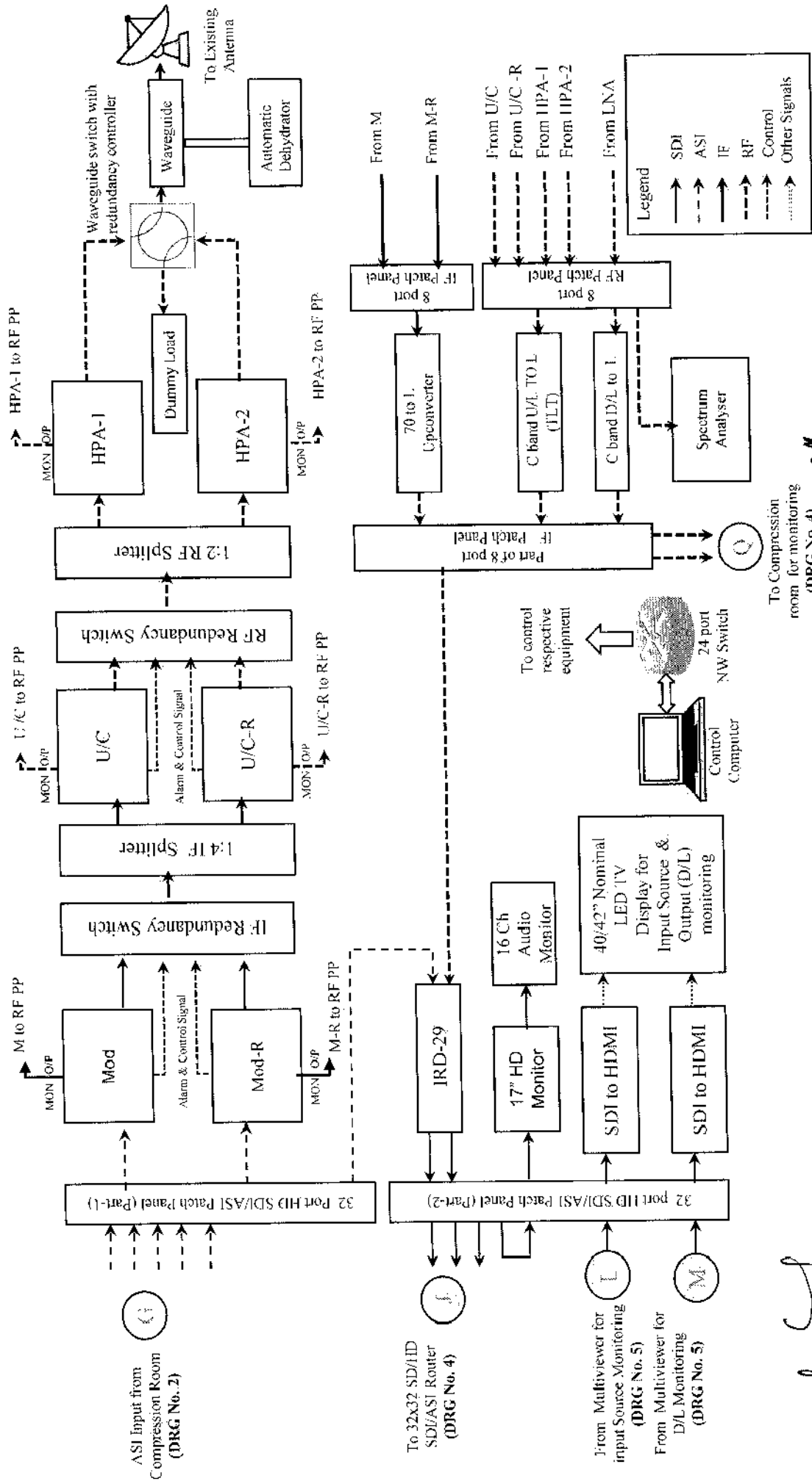

To Compression room for monitoring (DRG No. 4)

*Signature*

DRG No: 3  
Page No: 97

# Suggestive Block Schematic for SITC of Upgradation of Compression, Monitoring, RF and Power Supply System at Earth Station Pitampura – (Confidence Level Monitoring System)

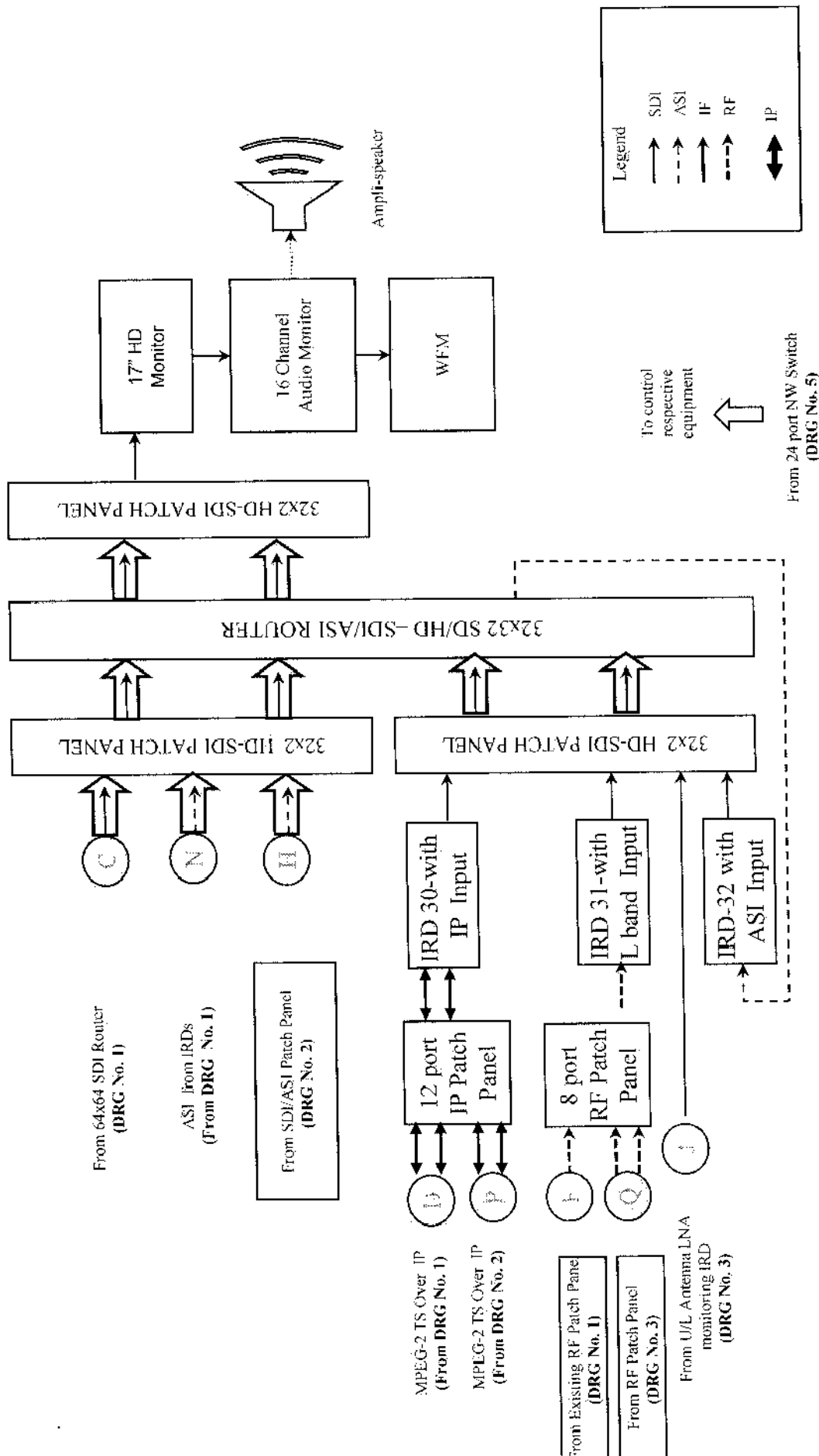

DRG No: 4  
Page No: 98

*Signature*

# Suggestive Block Schematic for SITC of Upgradation of Compression, Monitoring, RF and Power Supply System at Earth Station Pitampura – (Monitoring System)

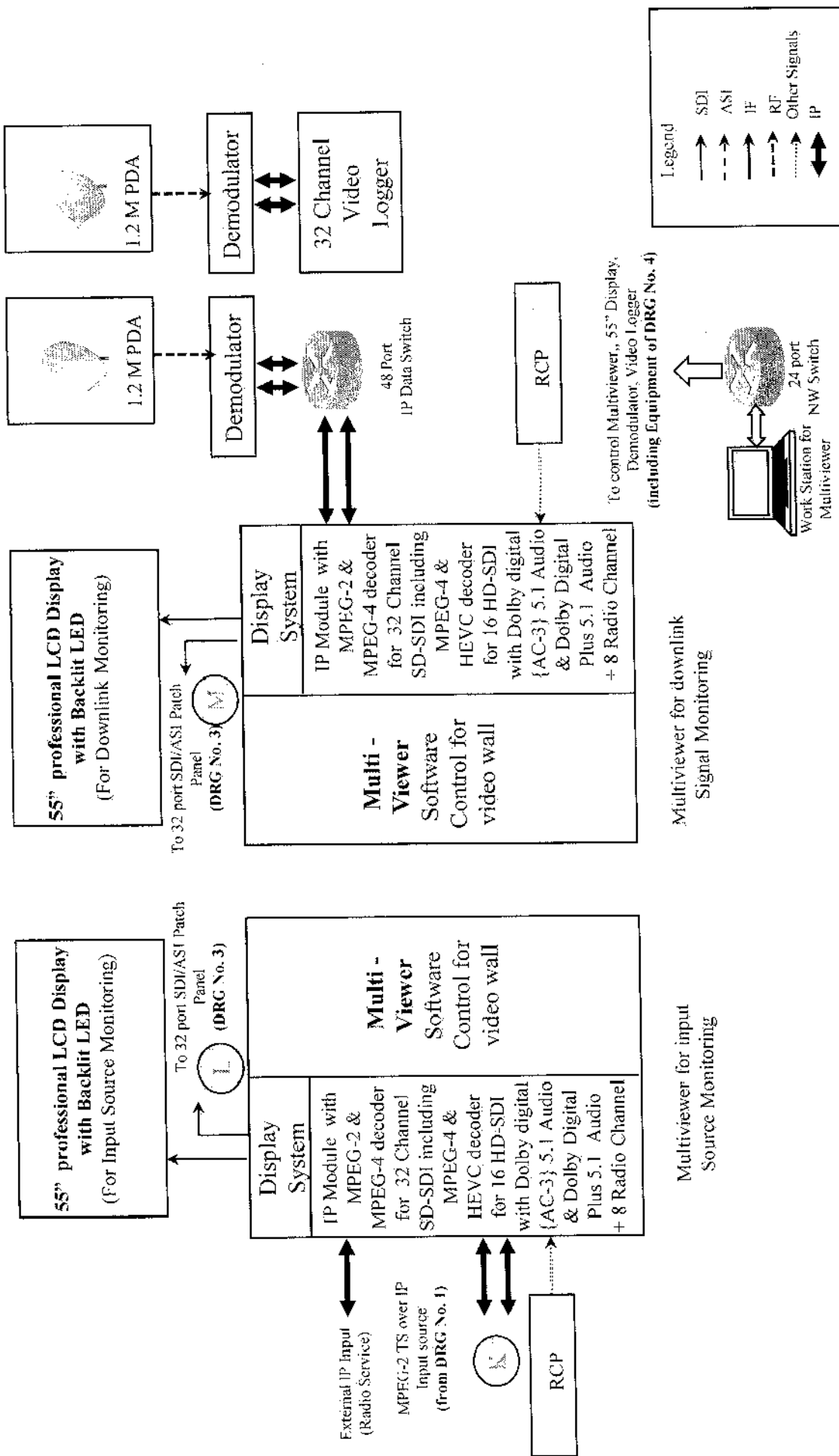

*Himanshu*

*fed*

**Suggestive Block Schematic for SITC of Upgradation of Compression, Monitoring, RF and Power Supply System at Earth Station Pitampura – (Single Line Diagram of Parallel Redundant 2x60 KVA UPS System)**

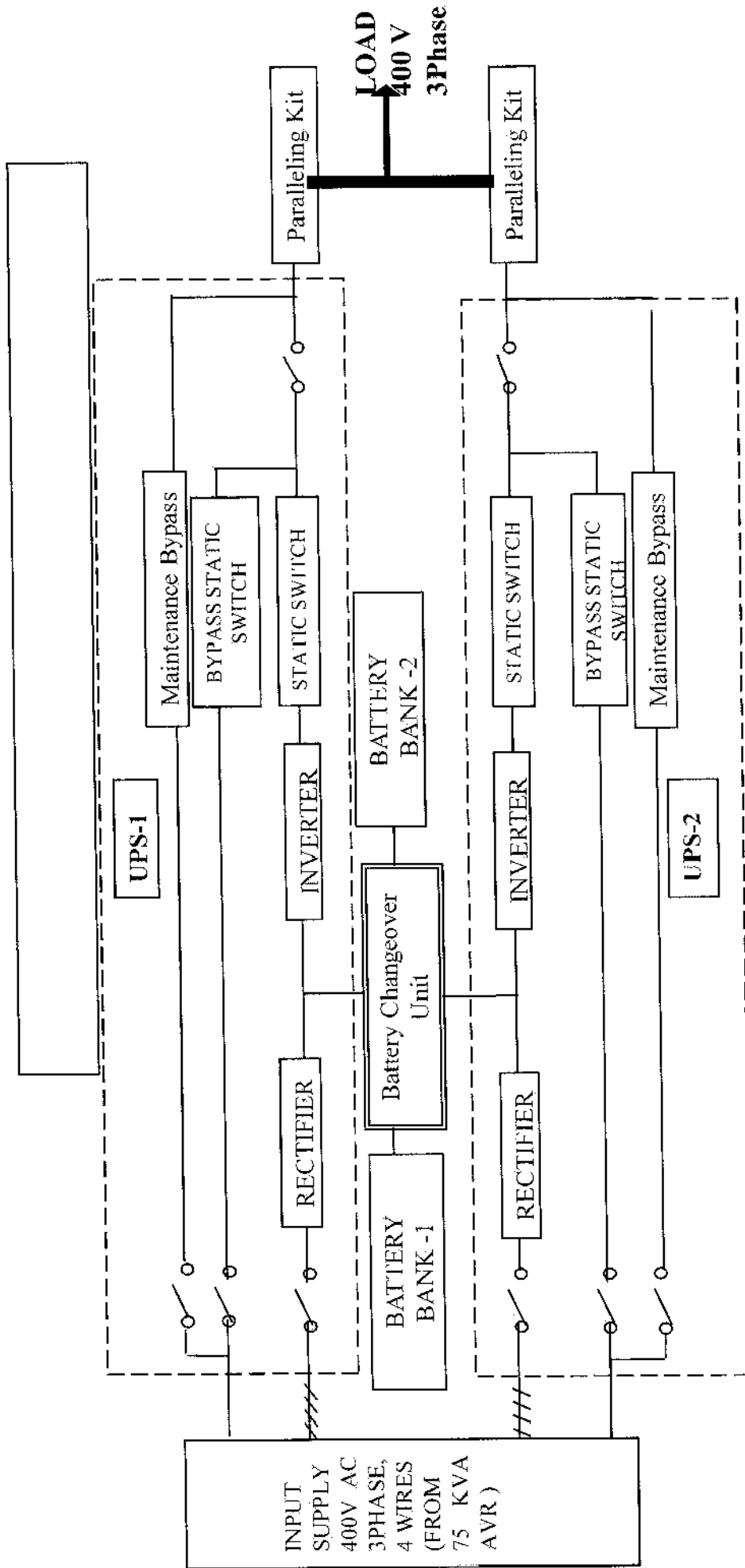

*Handwritten signature*

*Handwritten signature*



**Suggestive Block Schematic for SITC of Upgradation of Compression, Monitoring, RF and Power Supply System at Earth Station Pitampura - 2 x 60 KVA UPS (SINGLE MODULE -SUGGESTIVE CONFIGURATION)**

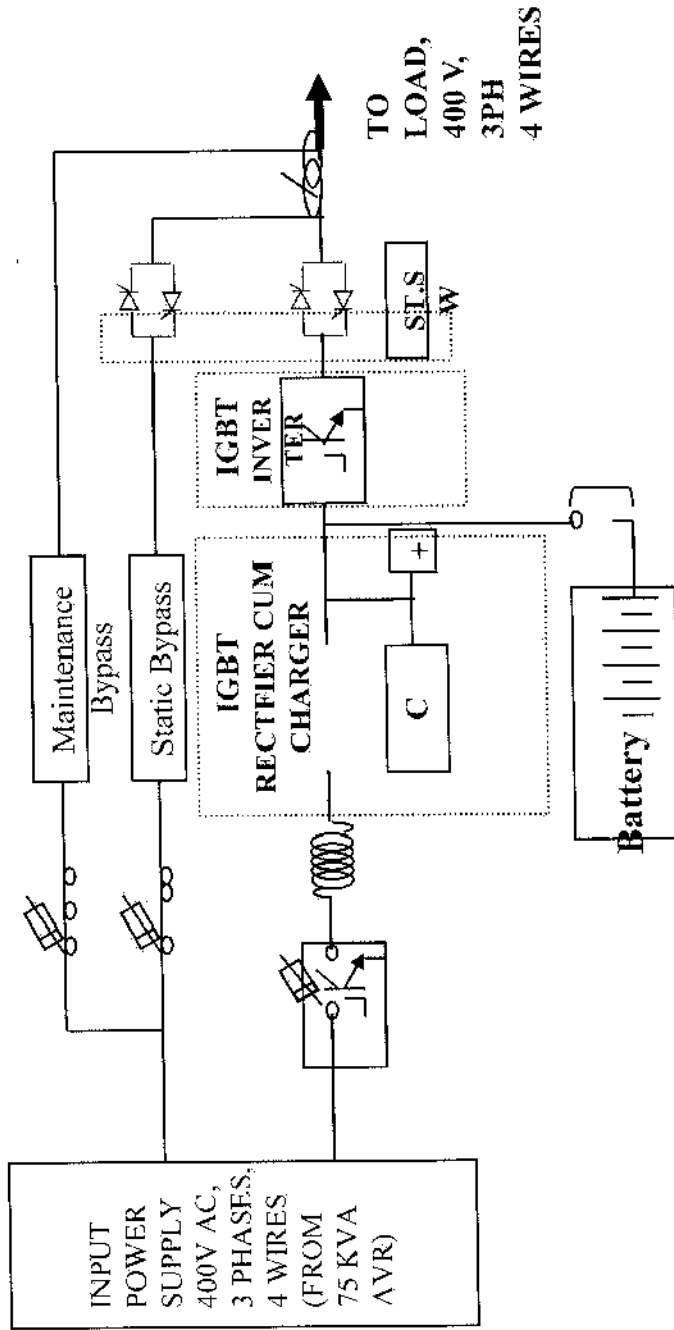

*Shimshu Gosh*

*SA*

*SA*

# Suggestive Block Schematic for SITC of Upgradation of Compression, Monitoring, RF and Power Supply System at Earth Station Pitampura – (Essential Power Supply System)

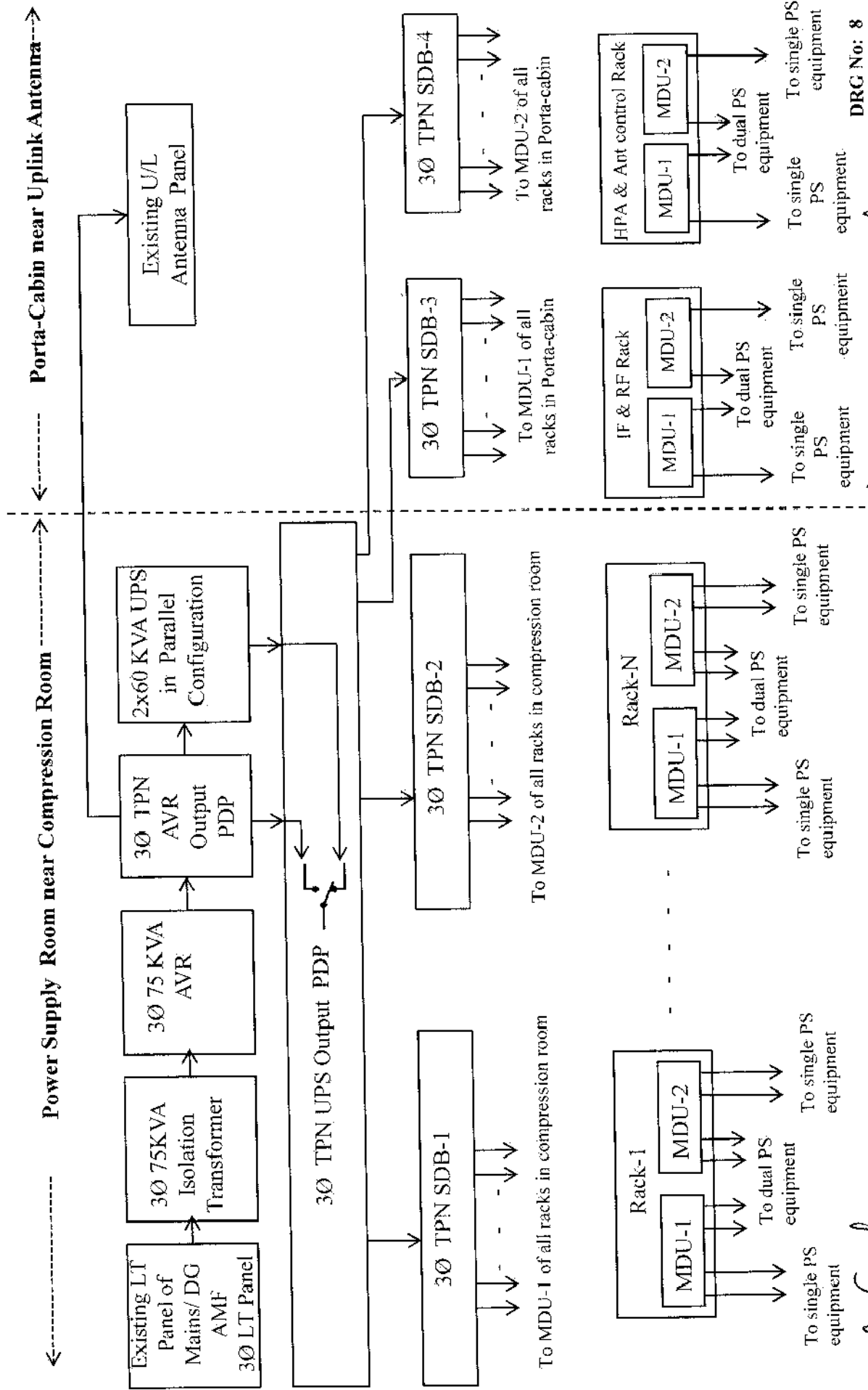

*Handwritten signature*

**Suggestive Block Schematic for SITC of Upgradation of Compression, Monitoring, RF and Power Supply System at Earth Station Pitampura – (Power Distribution, Temp & Humidity Monitoring in Racks)**

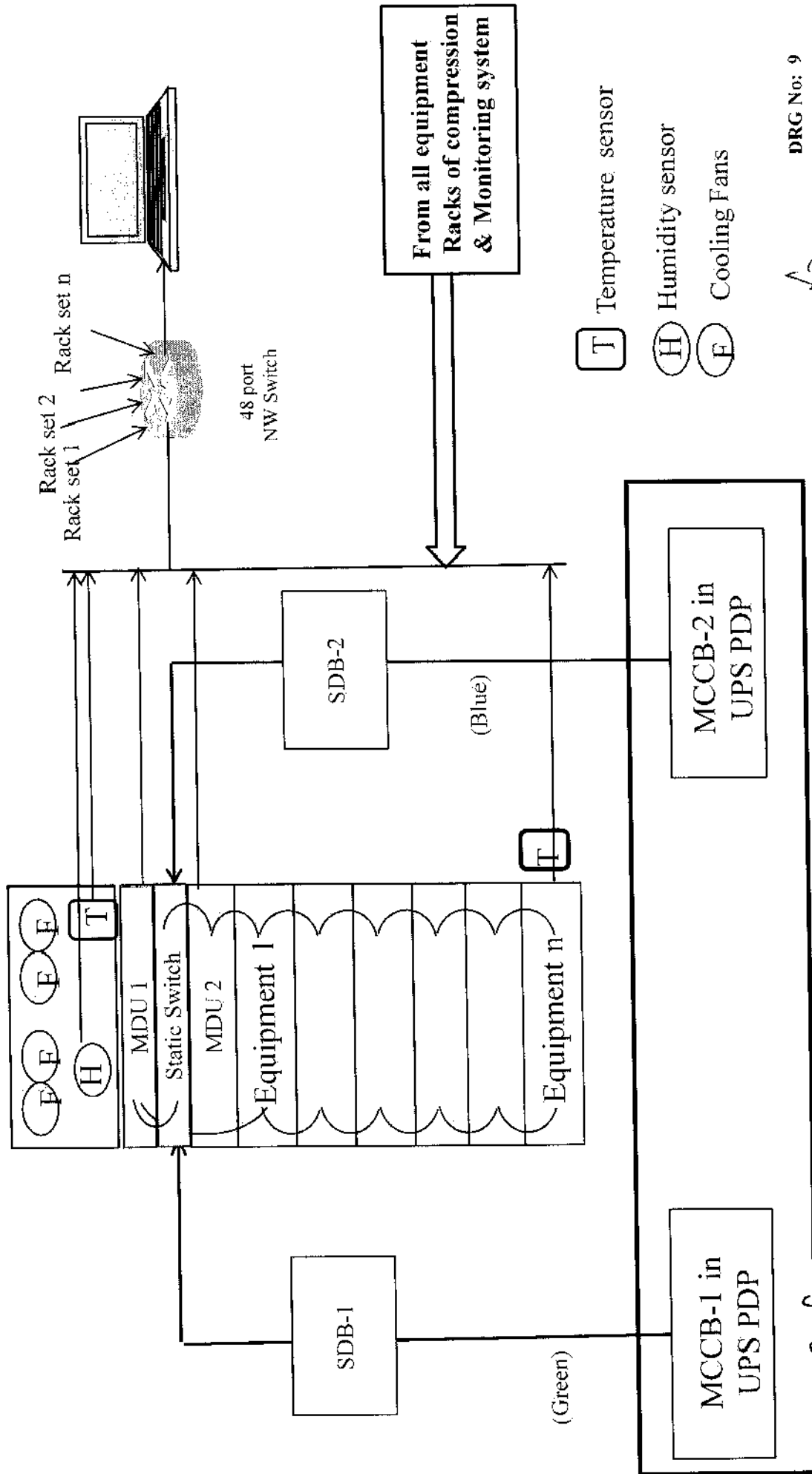

DRG No: 9  
Page No: 103

*[Handwritten signature]*

*[Handwritten signature]*

*[Handwritten signature]*

**Suggestive Block Schematic for SITC of Upgradation of Compression, Monitoring, RF and Power Supply System at Earth Station Pitampura – (Earth Pit Drawing)**

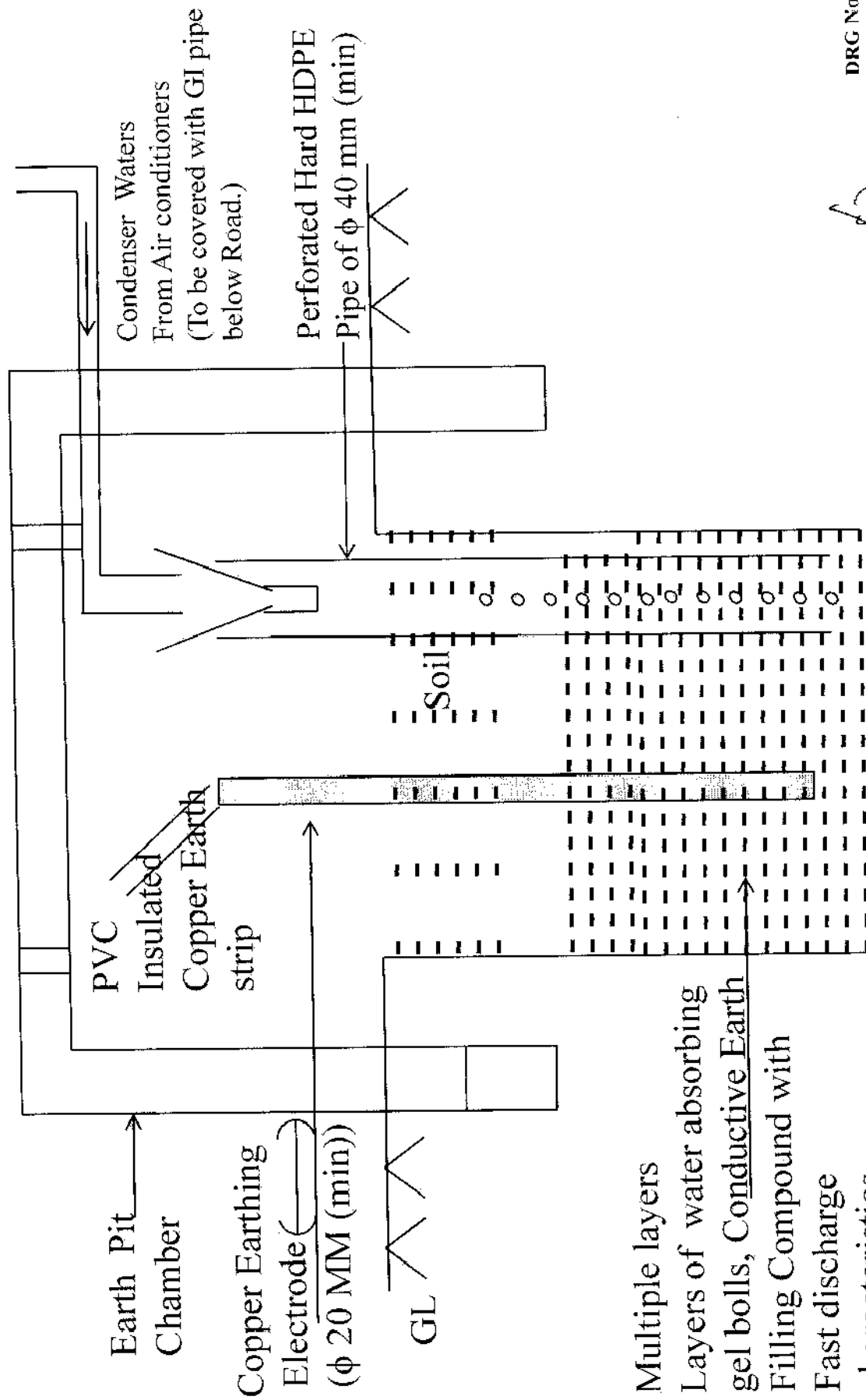

Multiple layers  
 Layers of water absorbing gel balls, Conductive Earth  
 Filling Compound with Fast discharge characteristics

*Handwritten signature*

DRG No: 10  
 Page No: 104

*Handwritten signature*

**Suggestive Block Schematic for SITC of Upgradation of Compression, Monitoring, RF and Power Supply System at Earth Station Pitampura – (Cable Support System)**

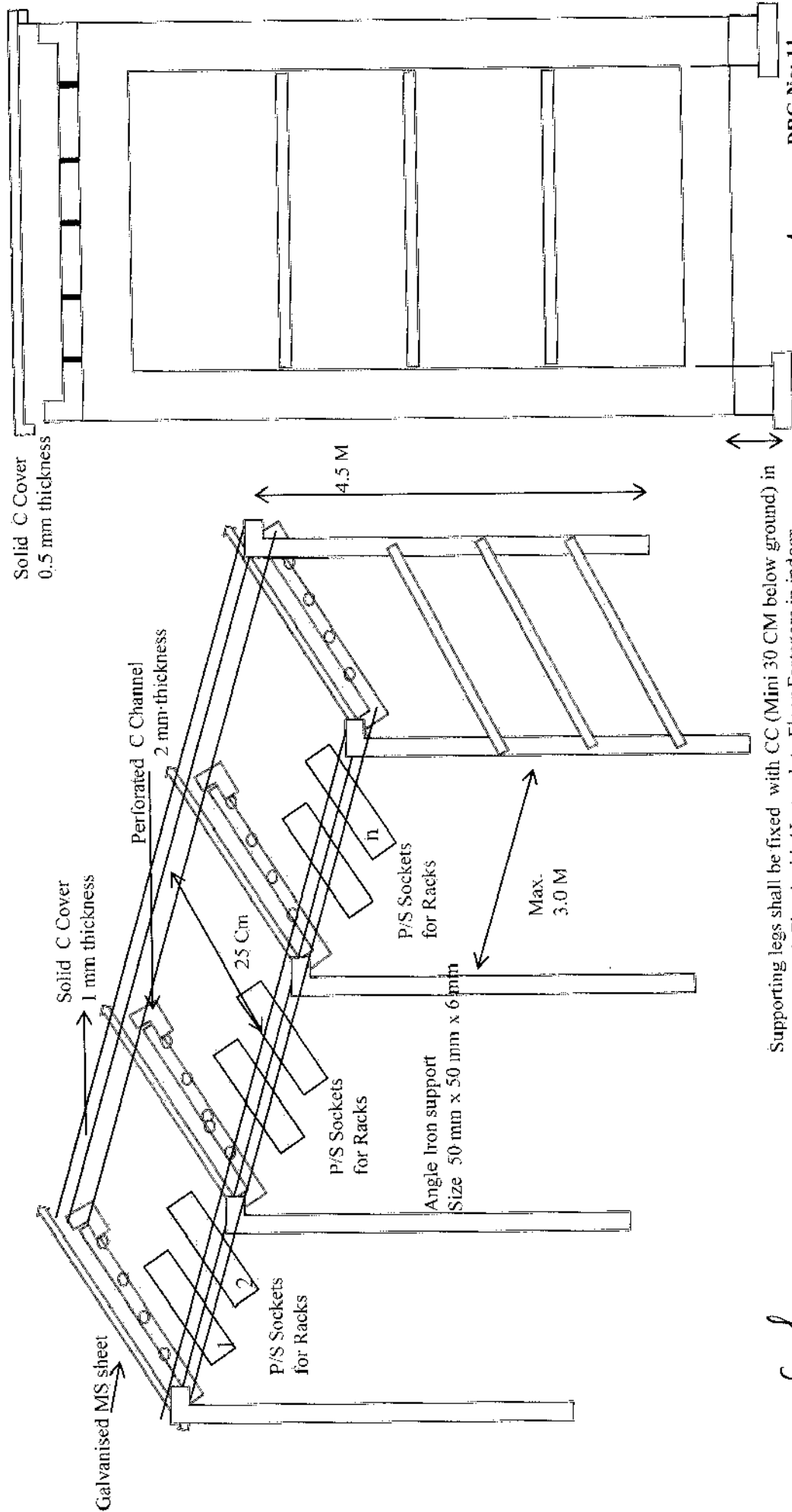

Supporting legs shall be fixed with CC (Mini 30 CM below ground) in Outdoor and Fitted with Heavy duty Floor Fasteners in indoor.

*Himanshu*

*[Handwritten signature]*

DRG No: 11  
Page No: 105

**Suggestive Block Schematic for SITC of Upgradation of Compression, Monitoring, RF and Power Supply System at Earth Station Pitampura – (Earth Terminal)**



*Jimenez*

*felt*

*12*

# Suggestive Block Schematic for SITC of Replacement of 1+1 HPA System of Earth Station DDK Delhi: (High Power Amplifier and Power Supply System)

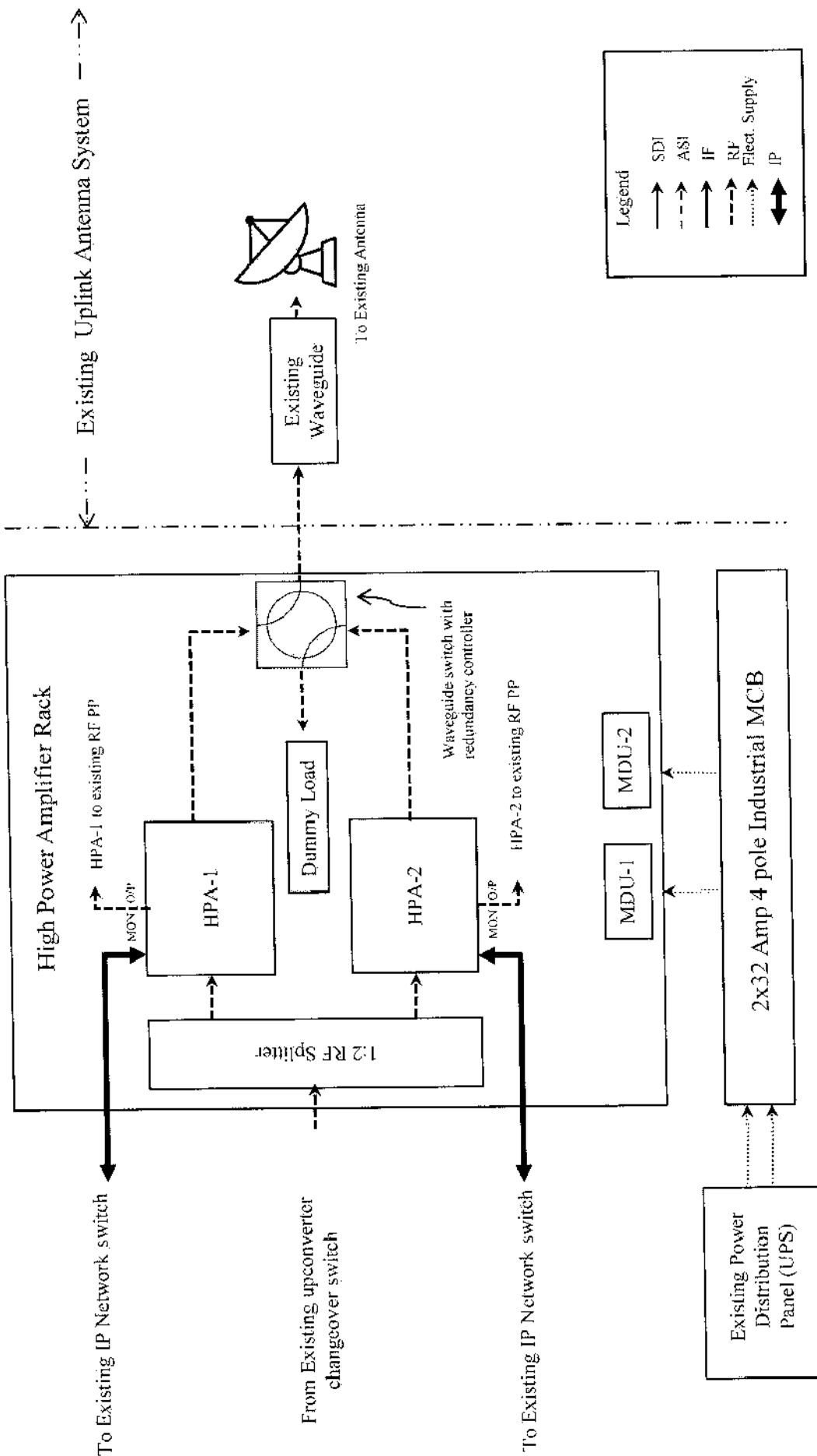

*Handwritten signature*

*Handwritten initials*

Annexure-I				
Specifications for SITC of Upgradation of Compression chain, Monitoring and Power supply system, Replacement of RF system of C-band Earth Station, Pitampura Delhi and Replacement of High Power Amplifier System of Earth Station, DDK Delhi				
Sl. No	Description of Item as per Specification (Suggestive BOM for Earth Station Pitampura)	Quantity as per suggestive BOM		Budgetary quote
		Qty	Unit	
<b>A</b>	<b>INPUT AND BASE BAND SYSTEM (DRG No. 1)</b>			
1	<b>L band Router (16x16) with dual redundant power supply consisting of :</b>			
a	Base unit fully wired including Cross Point module for 16x16 and control logic Module	2	Sets	
b	Hot swappable Dual Redundant Power supply unit	2	Sets	
c	X-Y Remote control panel with cable or Inbuilt Router control panel	2	Sets	
d	Necessary power supply to LNBCs ( one set with each Router)	2	Sets	
e	Low loss RF cable and matching "F/BNC" type connector with Gold plated pin as per site requirement (i) from existing RF patch panel to new Patch Panel (min 10 nos) i.e. 10 mtr x 10=100 mtr. min (ii) from new Patch Panel to input of 1:2 L Band splitter i.e. 3 mtr x 10=30 mtr min (iii) One output of each splitter to first 16x16 L band Router and other output of each splitter to second Router i.e. 3 mtr x 20= 60 mtr min (iv) from remaining 6 input of each L band Router to RF patch panel i.e. 3 mtr x 12= 36 mtr min.	1	lot	
f	RF Patch panel (16 Ports) for all input port of L band Router (two nos.) and RF Patch panel (16 Ports) for L band Input Source (one no) with matching "F/BNC" type connector with Gold plated pin of Canare or equivalent)	1	Set	
g	1:2 L Band splitter with DC pass through	10	Sets	
2	<b>Professional IRDs consisting of:</b>			
a	Professional IRDs with L-band inputs of DVB-S & DVB-S2, DVB-ASI & IP Input compliance decoder and DVB-ASI, HD-SDI, SD-SDI, AES/EBU, HD-SDI embedded audio, SD-SDI embedded audio, One downconverted SD-SDI of HD-SDI, Dolby digital (AC-3) 5.1 audio and Dolby Digital Plus 5.1 Audio (E-AC-3) output, MPEG-2 TS over IP output with Multi service filtering facility and having 4:2:0 & 4:2:2 compliant for MPEG-2, H.264/MPEG-4-AVC and 4:2:0 compliant for H.265/HEVC decoding and Common interface for hardware BISS mode-1 & BISS-E Compliant)	28	Nos.	
b	75 Ohm BNC Female to 110 Ohm AES/EBU XLR male adaptor/Impedance Converter and cable fitted with BNC male connector at both end (length - 1 mtr)	12	Sets	
c	Low loss RF cable and matching "F" type connector with Gold plated pin as per site requirement (5 meters per signal i.e. 5 x 32= 160 mtrs (min.) to be connected from L Band Router to IRDs as per DRG No. 1.	1	lot	
d	HD-SDI Video cables with matching connectors as per site Requirement (DRG No. 1) between the HD-SDI output port of all IRDs to HD-SDI Patch Panel (Min 10 mtr x 32 Nos =320 mtr)	1	lot	
e	HD-SDI Video cables with matching connectors as per site Requirement (DRG No. 1 & 4) between the ASI output port of all IRDs to HD-SDI Patch Panel for Monitoring (Min 10 mtr x 32 Nos=320 mtr)	1	lot	
3	<b>IP Data Switches and Network Switches consisting of:</b>			
a	(1+1) IP Data Switch 48 port with inbuilt dual power supply unit, rack mounting kit and required Software Licenses. (2 Nos per set)	1	Sets	
b	IP Network Switch 48 port with inbuilt dual power supply unit with rack mounting kit and required Software Licenses.	1	Set	
c	CAT-6 Cable with connector for wiring of rack and interconnection of equipment as per site requirement and drawing no 1. (Min 10 mtr x 3 nos x 28 nos IRD =840 meter per set)	1	Set	
4	Essential items/works(if any) to complete the installation of Input and baseband system	1	Set	
5	Installation, testing and integration of Input and Baseband system	1	job	
<b>B</b>	<b>Compression System (DRG No. 1 &amp; 2)</b>			
6	<b>64 x 64 SD &amp; HD-SDI router wired for all input and out put consisting of:</b>			
a	Base unit Fully wired for 64x64 Input and Output	1	Set	
b	Inbuilt hot swappable redundant Cross Point module for 64 x 64	1	Set	
c	Inbuilt hot swappable redundant controller/ logic modules	1	Set	
d	Inbuilt hot swappable Redundant Power supply unit	1	Set	
e	X-Y control panel with cable	1	Set	
f	Single Bus remote control panel with cable	1	No	
7	<b>HD-SDI Patch Panel and Patch cord consist of:</b>			
a	HD-SDI Patch Panel, 75 Ohm Impedence for all input and output ports of SDI Router as per DRG no. 1. (IRLU, Normal Through, self terminating type)	4	Nos.	
b	HD-SDI Video cables with matching connectors as per site Requirement (DRG No 1 & 2) between the HD-SDI Input Patch Panels to Output Patch Panel via 64x64 SDI Router and upto the Input of Encoders ( 10 mtr x 32 Nos =320 mtr)	1	lot	
c	Female to Female BNC Termination panel for all Input and Output of SDI Router	1	Set	
d	HD-SDI Patch Cord (Impedence -75 Ohm, Cable Length- 3 feet (Minimum))	24	Nos.	
e	HD-SDI Patch Cord (Impedence -75 Ohm, Cable Length- 10 feet (Minimum))	8	Nos.	
8	<b>Digital Encoder operating on 4:2:0 mode with MPEG-2, H.264/MPEG-4 and H.265/HEVC compression without any limitation by way of hardware &amp; software upgradation (including Staff Mux support) consisting of :-</b>			

Shimashu Cool

Full

1/3



a	Digital encoder with SDI Input signal for 32 SDTV channels in MPEG-2 & H.264/MPEG-4 compression including 16 HDTV channels in H.264/MPEG-4 & H.265/HEVC compression without any limitation by way of hardware & software upgradation. Each encoder chassis shall also be capable to take MPEG-2 TS over IP input and decode & re-encode SD & HD TV channels as per technical specification of tender document without any limitation by way of hardware & software upgradation. Noise reduction hardware/software for SD & HDTV. Four stereo audio channel including Dolby Digital (AC-3) 5.1 audio (Decoding & Encoding) & Dolby Digital Plus 5.1 audio (decoding & Encoding) with audio level processor & loudness control, logo inserter, Ancillary data and Dual redundant power supply units for all encoders.	1	Set	
b	Two Redundant Digital encoder chassis similar to Main Chassis per set without any limitation by way of hardware & software upgradation.	1	Set	
9	<b>IP Data and Network Switches Consisting of:</b>			
a	(1+1) IP Data Switch 48 port with inbuilt dual power supply unit, rack mounting kit and required Software Licenses (2 Nos. per set)	1	Set	
b	IP Network Switch 48 port with inbuilt dual power supply unit with rack mounting kit and required Software Licenses.	1	No.	
c	CAT-6 Network Cable with connector for wiring of rack and interconnection of equipment as per site requirement and drawing no 2. ( min. 40 x 3=120 mtr per set)	1	Set	
10	<b>IP Encapsulator cum Mux for Statistical Multiplexing in (1+1) configuration consisting of:</b>			
a	IP Encapsulator cum Mux in (1+1) configuration for Statistical Multiplexing having: (i) Four Independent ASI Input Port with Licenses (ii) Two independent ASI output port with licenses and two mirror ASI output for monitoring (iii) Eight Independent IP data Port (bi-directional) with licenses (for Input data, Independent MPEG-2 TS over IP Output for transmission, Ancillary data, Control & Management)	1	Set	
11	<b>16x16 or better matrix ASI router (SDI compatible) wired for all input and out put consisting of:</b>			
a	Base unit fully wired for 16x16 or better matrix Input and Output	1	Set	
b	Inbuilt controller/ logic modules	1	Set	
c	Inbuilt auto switchable Redundant Power supply unit	1	Set	
d	X-Y control panel with cable	1	Set	
e	Single Bus remote control panel with cable	1	Set	
12	<b>HD-SDI Patch Panel and HD Video cables consist of:</b>			
a	HD-SDI Patch Panel, 75 Ohm Impedance for all input and output ports of ASI/SDI Router as per DRG no. 2 ( IRU, Normal Through, self terminating type )	1	No.	
b	HD-SDI Video cables with matching connectors as per site Requirement (DRG No. 2) between output of IP Encapsulator cum MUX to HD SDI Patch Panels, HD SDI Patch Panel to the input of ASI Router and output of ASI Router to HD SDI Patch panel. ( min. 16 x 5m=80 mtr) and between Compression room and HPA porta cabin ( minimum Distance 30 mtr ) as per site requirement ( min. 8x 50m=400 mtr) (total 400+80=480 mtr min)	1	Set	
13	<b>Network Management System(NMS) for Compression equipment consisting of:</b>			
a	Compression equipment control system Software	1	Set	
b	Compression equipment control system Hardware consisting of rack mounted main server in 1-1 master-slave configuration or Cluster configuration with client license, each server with dual power supply modules, and KVM switch, Integrated Key Board, mouse & rack mount foldable display monitor.	1	Set	
c	Client work station with required licenses for remote monitoring of all NMS consists of: 17" or bigger display, keyboard with PC (Intel i7 or better processor, 8 GB or More DDR RAM, 800 GB or more HDD, Windows 11 or latest operating system, minimum 4 nos. USB ports, 1 AGIP and 3 PCI Slots, Integrated Audio with external speakers to remotely control all the supplied equipments through Ethernet ports.	3	Sets	
d	24 port IP Network switch for NMS monitoring with Client Work station in remote locations	3	Sets	
e	CAT-6 Cable with connector as per site requirement to connect the NMS with respective equipment as per drawing no. 2 (Min 48x10 meter=480 meter per set)	1	Set	
14	Two nos GPS enabled NTP servers and GPS Antenna with associated accessories for network time synchronization of all broadcast equipment and servers installed in the earth station.	1	Set	
15	Essential items/Works (If any) to complete the installation of Compression system	1	Set	
16	Installation, testing and integration of Compression system	1	job	
C	<b>IF, RF and High Power Amplifier (HPA) System (DRG No. 3)</b>			
	<b>Digital Satellite Modulators in (1+1) mode consisting of:</b>			
17	Digital Satellite Modulators capable of Modulating in DVB-S and DVB-S2 (one at a time).	2	2 Nos.	
18	RF Redundancy switch for managing redundancy of above Modulators.	1	1 No.	
19	1:4 passive IF splitter	1	1 No.	
	<b>Up converters in (1+1) configuration consisting of:</b>			
20	C Band Up converter			
21	RF Redundancy switch (C- band) for upconverter	2	2 Nos.	
22	Essential item to complete the installation of Modulator and Upconverter system (if any)	1	1 No.	
23	Installation, testing and system integration Modulator and Upconverter system	1	1 Set	
	<b>High Power Amplifier System</b>	1	job	
24	<b>TWT/SSPA High Power Amplifier system in 1+1 configuration consisting of:</b>			
a	1000 watt C-Band 1 linear Power TWT/SSPA with integral lineariser (Indoor type)	1	Set	
b	Redundancy Controller for above 1-1 configuration of HPA	2	Nos.	
c	1:2 low power RF Splitter (C-Band uplink frequency) (To be mounted in HPA Rack)	1	Set	
d	Waveguide switch with rack mounting kit for 1+1 Redundant 1 KW linear Power TWT HPA system	1	No.	
e	Inter connecting rigid wave guide assembly with bends from each HPA to Waveguide switch.	1	lot	
f	Dummy Load / Termination for 5.85 to 6.425 GHz Freq (Min 1500 Watts, VSWR < 1.1) along with accessories	1	No.	
g	Automatic Dehydrator (3-5 PSI user configurable) with required accessories and front panel Display with remote access through ethernet/SNMP etc and rack mounting kit.	1	set	
h	Prewired Rack for 1+1 Redundant 1 KW linear Power TWT/SSPA HPA system with MDU	1	set	

*Shimanku Goud*

*Sh*

*Sh*

t	Essential item to complete the installation of HPA System (if any)	1	Set	
j	Installation, testing and system integration of HPA System	1	job	
25	<b>RF Rigid waveguide, Flexible waveguide, Waveguide E plane, H Plane, Twisted Waveguide, Connectors etc.</b>			
a	C-Band, 90 degree rigid waveguide bend with CPR 137F/G Flange connector (Length-0.30mtr max (each leg))			
	i) H-plane bend	1	No.	
	ii) E-plane bend	1	No.	
b	Cross Guide Directional Coupler for Frequency range 5.85 to 6.425 GHz with CPR 137 F/G Flange connector	2	Nos.	
c	C-Band, Twisted rigid waveguide, clockwise with CPR 137 F/G Flange connector (Length-0.30 mtr max.)	2	Nos.	
d	Supply of Flexible Waveguide with CPR 137G Flange connector at one end and CPR 137F Flange connector at other end as per detailed below:-			
	i) Length-0.6 mtr with gasket and screw kit	2	sets	
	ii) Length 1.0 mtr with gasket and screw kit	2	sets	
e	Supply of Flexible Waveguide with CPR 137 F/G Flange connector as per detailed below.			
	i) Length-0.6 mtr with gasket and screw kit	2	sets	
	ii) Length 1.0 mtr with gasket and screw kit	2	sets	
f	Supply and installation of aluminum duct or HDPE pipe as per site requirement of suitable size to take out hot air of each HPA from HPA room to outside the room (Minimum length-4 mtr)	1	job	
g	16 port or more C-band RF Patch Panel with N-type Female connector at both end having gold plated inner pin, 2 RU, 19" Rack mountable.	1	No.	
h	20 port or more L-band Patch Panel with F-type Female connector having gold plated inner pin, 19" Rack mountable.	1	No.	
26	<b>Elliptical (Semi Rigid) RF Waveguide to connect existing uplink Antenna system as per site requirement (minimum length 7 mtr)</b>	1	Set	
27	<b>Suitable waveguide connector for connecting the Elliptical waveguide at both end having CPR 137G/F flange with gasket and screw kit and pressure window at both end</b>	1	Set	
28	<b>Essential item (if any) to complete the installation of RF system</b>	1	set	
29	<b>Installation, Testing and System Integration of Waveguide system</b>	1	Job	
D	<b>Confidence level Monitoring System (DRG No. 4)</b>			
30	<b>Confidence level Monitoring system consisting of:</b>			
a	17 inch (Nominal) LCD (TFT) Professional Broadcast Colour Monitor with integrated speakers	1	No.	
b	Professional grade Integrated Audio/video Monitor with >= 4" TFT/LCD screen of high resolution and integrated speakers. It should accept 2 HD/SD-SDI Inputs with relocked output, including audio De-Embedder, decoding of Dolby digital (AC-3) 5.1 audio and Dolby Digital Plus 5.1 Audio	1	No.	
c	Prof. IRDs {with L-band inputs of DVB-S & DVB-S2, DVB-ASI & IP input} with DVB-ASI, SD-SDI, HD-SDI, AES/EBU, HD SDI embedded audio, SD-SDI embedded audio, One downconverted SD-SDI of HD-SDI, Dolby digital (AC-3) 5.1 audio & Dolby Digital Plus 5.1 Audio (E-AC-3) output, MPEG-2 TS over IP output with Multi service filtering facility and having 4:2:0 & 4:2:2 compliant for MPEG-2, H.264/MPEG-4-AVC and 4:2:0 compliant for H.265/HEVC decoding and Common Interface slot hardware, BISS mode-1 & BISS-E Compliant	2	Nos.	
d	Prof. IRDs {with DVB-ASI & IP input} with DVB-ASI, SD-SDI, HD-SDI, AES/EBU, HD SDI embedded Audio, SD-SDI embedded audio, One downconverted SD-SDI of HD-SDI, Dolby digital (AC-3) 5.1 audio & Dolby Digital Plus 5.1 Audio (E-AC-3) output, MPEG-2 TS over IP output with Multi service filtering facility and having 4:2:0 & 4:2:2 compliant for MPEG-2, H.264/MPEG-4-AVC and 4:2:0 compliant for H.265/HEVC decoding and Common Interface slot hardware, BISS mode-1 & BISS-E Compliant	2	Nos.	
e	32 x 32 SDI Router with one X-Y panel, one Single Bus Remote Control Panel, dual Redundant power supply and accessories	1	Set	
f	32x2 (HD-SDI/ASI) Patch Panel, 75 Ohm Impedance as per DRG no. 3. (1RU, Normal Through, self terminating type) {(32x2)x3}	3	Nos.	
g	High Quality Digital Ampli-Speaker having digital AES/EBU and analog Audio Input facility and suitable power supply	1	Set	
h	8 port RF Patch Panel	1		
i	12 port IP Patch Panel (RJ-45)	1	Set	
j	IP Patch card with connector (RJ-45)	2	Sets	
k	HD-SDI Video cables with matching connectors for connection between patch panel, 32x32 router and all monitoring equipment as per site requirement and drawing no. 4 & 5 (Min 32x10 mtr-320 mtr per set)	1	Set	
l	CAT-6 Cable with connector for wiring of rack and interconnection between 24 port network switch to all equipment as per drawing no. 4 & 5 (Min 24x10 mtr-240 mtr per set)	1	Set	
E	<b>Input and Downlink Monitoring (DRG No. 5)</b>			
31	<b>Input and Downlink Monitoring of SDTV and HDTV Channels consisting of:</b>			
a	Multi viewer display system with remote panel for MPEG-2 TS over IP streams of Input Source signal, Each set shall have inbuilt MPEG-2 & MPEG-4 decoders of 32 SDTV with embedded audio including MPEG-4 & HEVC Main-10 decoders of 16 HDTV with Dolby Digital (AC-3) 5.1 audio & Dolby Digital Plus 5.1 audio Channels with two independent video display output; and 8 Radio Service as per drawing no. 5	1	Set	

*Heinrichs*

*SK*

*7*

b	Work station with software licenses including one client licence for controls and configuration of Display on 55" Display system consists of: 17" or bigger display, keyboard with PC (Intel i7 or better processor, 8 GB or More DDR RAM, 800 GB or more HDD, Windows 11 or latest operating system, minimum 4 nos. USB ports, 1 AGP and 3 PCI Slots, Integrated Audio with external speakers to remotely control all the supplied equipments through Ethernet ports	1	Set	
c	24 port IP Network switch for Management of monitoring equipment	1	Set	
d	De-Modulator (DVB-S & S2) with Common interface slot hardware (Max 8 Service per CI slot) and MPEG 2 TS over IP output for 32 TV service and 4 Radio service per set (One chassis should consist of multiple modules)	2	Set	
e	Multi viewer display system with remote panel for MPEG-2 TS over IP streams of Down link signal Each set shall have inbuilt MPEG-2 & MPEG-4 decoders of 32 SDTV with embedded audio including MPEG-4 & HEVC decoders of 16 HDTV with Dolby Digital (AC-3) 5.1 audio & Dolby Digital Plus 5.1 audio Channels with two independent video display output, and 8 Radio service as per drawing no. 4.	1	Set	
f	32 Channel video logger with minimum 90 days content storage facility and required software & licenses	1	set	
g	IP Data Switch 48 port with inbuilt dual power supply unit, rack mounting kit and required Software Licenses	1	Set	
h	Active splitter(1- band) 1-Input and 8 Output	3	Sets	
i	ASI splitters (100 Mbps) 1-Input and 4 Output	5	Nos	
j	55 inch (nominal) LED display system with wall mount kit, cables and associated accessories	2	Sets	28% GST
k	Dolby Digital 5.1 audio Home theater	1	Set	
l	C - band receive antenna 120 cm with C band Feed & LNBC	3	Sets	
m	RF cables as per site requirement (minimum 150 mtrs)	1	lot	
n	Essential items/Works (If any) to complete the installation of above Input and downlink monitoring system and Confidence Monitoring System	1	Set	
o	Installation, testing and integration of Input and downlink Monitoring System and Confidence Monitoring System	1	job	
<b>F</b>	<b>IF and RF Monitoring (DRG No. 3)</b>			
<b>32</b>	<b>IF and RF Monitoring consisting of:</b>			
a	TLT (C-Band uplink frequency to L-Band Down Converter) along with rack mounting kit.	1	Set	
b	C Band Down converter (C-Band downlink frequency to L Band Frequency)	1	No	
c	Up-converter (70 MHz to L band)	1	No	
d	8 port or more C-band RF Patch Panel, with 50 Ohm N-type Female connector at both end having gold plated inner pin, 2 RU, 19" Rack mountable.	2	Nos	
e	8 port or more IF-Patch Panel, with 75 Ohms F-type Female connector having gold plated inner pin, 19" Rack mountable.	1	No.	
f	32x2 HD-SDI/ASI Patch Panel, 75 Ohm Impedance as per DRG no. 3. (1RU, Normal Through, self terminating type) (32x2)x3	1	No.	
g	HD-SDI to HDMI Converter	2	Nos	
h	42/48 Inch (Nominal) LED display System with Stand as per site requirement	1	Set	
i	17 Inch (Nominal) LCD (TFT) Professional Broadcast Colour Monitor with integrated speakers	1	No	
j	Professional grade Integrated Audio/video Monitor with >= 4" TFT/LCD screen of high resolution and integrated speakers. It should accept 2 HD/SD-SDI Inputs with relocked output, including audio De-Embedder, decoding of Dolby digital (AC-3) 5.1 audio and Dolby Digital Plus 5.1 Audio	1	No	
k	Low loss RF cable and matching "F" type connector with Gold plated pin Inter-connecting RF cables with connector from output port of RF Redundancy Switch to HPAs and various monitoring port of Modulators, upconverters, Redundancy Switch, HPAs, TLT, Down converter etc to patch panel (RF Cable 50 ohm 5x30 meter=150 mtr and RF Cable 75 ohm 2x50 mtr) as per site Requirement (DRG No. 3)	1	lot	
l	19" Rack Mountable Foldable 17" or bigger display, keyboard (with DigiPad & Mouse Switches) with PC (Intel i7 or better processor, 8 GB or More DDR RAM, 800 GB or more HDD, Windows 11 or latest operating system, minimum 4 nos. USB ports, 1 AGP and 3 PCI Slots, Integrated Audio with external speakers to remotely control all the supplied equipments through Ethernet ports and should be connected to all the equipment through Fast Ethernet Switch using properly rack wired CAT-5 or CAT-6 cable and RJ-45 connectors.	1	1 lot	
m	10/100 Fast Ethernet Switch (24-Ports, one -RU)	2	2 Nos.	
n	CAT-6 Cable with connector from 24 port network switch to all equipment as per site requirement and drawing no. 3 (Min 25x10 mtr=250 meter per set)	1	Set	
o	Essential items/works (If any) to complete the installation of above monitoring system	1	Set	
p	Installation, testing and integration of above Monitoring System	1	job	
<b>33</b>	<b>Provision of Cable tray (DRG No. 11)</b>			
a	Providing & installing cable tray with cover on top of equipment racks as per site requirement for laying of all cables as per drawing	1	job	
b	Installation, testing and integration of Cable Tray	1	job	
<b>G</b>	<b>MEASURING EQUIPMENT</b>			
<b>34</b>	Digital waveform monitor (with Measurement facility)	1	Set	
<b>35</b>	Spectrum Analyzer (9kHz to 26.5 GHz or better) with required probe and accessories	1	Set	
<b>36</b>	Colour laser Printer with network printing facility for A4 size	1	Set	
<b>37</b>	B/W laser printer with network printing facility for A3 size	1	Set	
<b>38</b>	Any other essential items/Works to complete the Measuring system	1	Set	
<b>39</b>	Installation, testing and system integration of Measuring System	1	job	
<b>H</b>	<b>POWER SUPPLY SYSTEM (DRG No. 6, 7 &amp; 8)</b>			
<b>40</b>	75 KVA, 3 Phase Delta to Star Isolation Transformer	1	Set	
<b>41</b>	75 KVA, 3 phase+Neutral Oil Cooled AVR	1	Set	

Heimanshu

lok

15/2

42	2x60KVA (3 Phase) Uninterrupted Power Supply (UPS) operating in (1 + 1) redundant parallel load sharing mode with Battery backup of 15 minutes (min) for each UPS. The isolation transformer will be provided at the output of each UPS, internally for suitable rating (minimum 60KVA) consisting of:	1	Set	
a	2x60KVA (3 Phase) Uninterrupted Power Supply (UPS)	1	Set	
b	Audio Visual Remote Monitoring Panel of UPS with cable.	1	Set	
c	12V Maintenance Free VRLA Battery, Minimum 50000 VAH Battery Bank with each UPS. Battery Changeover system & Battery bank stands (one battery bank per UPS)	1	Set	
d	Internal Isolation Transformer	1	Set	
43	AVR Output PDP with one incoming power supply controlled by 4 pole industrial MCCB and outgoing power supply to all connected PDP/UPS/Existing uplink antenna panel to meet the requirement of all supplied equipment, controlled by suitable industrial TPN MCBs with 30% spare capacity to connect additional SDBs in future. Including digital Volt meter, CT based digital current meter and phase indicator	1	Set	
44	UPS Output PDP with dual incoming power supply controlled by 4 pole industrial MCCBs (any one selectable at a time) and outgoing power supply to all connected SDBs to meet the requirement of all supplied equipment, controlled by suitable industrial TPN MCBs with 30% spare capacity to connect additional SDBs in future. Including digital Volt meter, CT based digital current meter and phase indicator	1	Set	
45	Copper LT Power Supply cables with suitable rating to meet the requirement of all equipment in Earth Station. (i) Existing LT Panel of Mains/ DG AMF LT Panel & Isolation Transformer (ii) Isolation Transformer & AVR (iii) AVR & AVR PDP (iv) AVR PDP & UPS output PDP (v) AVR PDP & UPS (vi) AVR PDP & Existing U/L Antenna Panel (vii) UPS & UPS output PDP (viii) UPS output PDP & SDB 1 to 4 (ix) SDB 1 to 4 & all racks as per DRG No. 8	1	Lot	
46	SDBs with 4 pole industrial MCCBs to meet the requirement of all supplied equipment with 30% (Nominal) spare capacity to connect additional rack load in future	4	Nos	
a	SDBs with industrial MCCBs & MCBs and three core copper power supply cables to meet the requirement of all equipment supplied in compression room connected with (1+1) UPS power supply system	1	Set	
b	Supply, Laying and Integration of Power supply Cables (4 Core Copper) between (1+1) UPS PDPs and above said SDBs ( Minimum length-20 mtr)	1	Set	
47	Any other essential items/Works to complete the Power supply system	1	job	
48	Installation, testing and integration of Power Supply System	1	job	
I	<b>MISCELLANEOUS ITEMS</b>	1	job	
49	Control & operators table made of powder coated MS sheet or aluminium matching with existing table to install remote operations & control computer, digital waveform monitors, Picture monitors, monitoring panel with stereo Loud speaker and other relevant equipments.	1	job	
50	Required no. of 19" 1000 mm (depth) equipment rack frames (min 6 nos in compression room and 1 no. in Porta-cabin) including Installation material, audio, video, RF cables etc with matching BNC, HD connectors, CAT-6 cable with RJ 45 Connector.	1	Set	
51	Required no of Mains Distribution Units and Single Phase Auto Changeover Switch (Min 1 no. Single Phase Auto Changeover switch and 2 nos of MDUs per Rack i.e. Total Min 7 Single Phase Auto changeover Switch and Min 14 Nos MDUs) with sequential delayed output on start up, output status LED and IEC-3 pin (for those equipment which have single power supply input) for each equipment in every rack.	1	Set	
52	Industrial type 3 pin Male-Female connector ( Min 12 nos ) as per site requirement	1	Set	
53	Earthing system and earth pits (Minimum 7 Nos) (Earth Resistance of each pit < 1 ohm) Sample picture is enclosed at DRG No.10	1	Set	
54	Installation material and laying of cables protection pipes	1	job	
55	One raised platform/ trolley with wheel and braking arrangements to reach up to overhead cable tray	1	Set	
56	Set of tools as per Annexure VIII of Appendix-D	1	Set	
57	Integration, Testing & Commissioning of complete supplied system.	1	job	
J	<b>DOCUMENTATION</b>	1	job	
58	Technical manuals ( Hard Copy) for all the equipment supplied	2	Sets	
59	Technical manuals (Softcopy) for all the equipment supplied on USB with Search facility etc). (Technical Manual (Softcopy) is to be distributed as follows: 2 Set for the station, 1 Set for DG DD and 1 Set for ADG (NZ))	4	Sets	
60	All software backups are to be supplied on USB.	2	Sets	
K	<b>TRAINING</b>	2	Sets	
61	Three separate Seminars (including theoretical & Practical training, hands on experience) for Doordarshan personnel at site. Atleast, One working day Training of each module shall be delivered by the factory Engineer/personnel of OEM. ( This training period is not part of Delivery period).			
a	Base band Equipment (01 working day)	1	job	
b	Digital compression system including NMS (02 working days)	1	job	
c	Monitoring and measurement equipment (01 working day)	1	job	
d	Power Supply System (01 working day)	1	job	

*Shimavola*

*Lok*

*2*

Sl. No	Description of Item as per Specification (Suggestive BOM for DDK Delhi)	Quantity as per suggestive BOM		Budgetary Quote (INR)
		Qty	Unit	
<b>A</b>	<b>High Power Amplifier System (DRG No. 13)</b>			
<b>1</b>	<b>TWT/SSPA High Power Amplifier system in 1+1 configuration consisting of:</b>	1	Set	
a	1000 watt C-Band Linear Power TWT/SSPA with integral lineariser (Indoor type)	2	Nos.	
b	Redundancy Controller for above 1+1 configuration of HPA	1	set	
c	1:2 low power RF Splitter (C-Band uplink frequency) (To be mounted in HPA Rack)	1	No.	
d	Waveguide switch with rack mounting kit for 1+1 Redundant 1 KW linear Power TWT HPA system	1	No.	
e	Inter connecting rigid wave guide assembly with bends from each HPA to Waveguide switch.	1	lot	
f	Dummy Load / Termination for 5.85 to 6.425 GHz Freq (Min 1500 Watts, VSWR < 1.1) along with accessories	1	No.	
g	Prewired Rack for 1+1 Redundant 1 KW linear Power TWT/SSPA HPA system with MDU	1	set	
h	Essential item to complete the installation of HPA System (if any)	1	1 Set	
i	Installation, testing and system integration of HPA System	1	job	
<b>2</b>	<b>RF Rigid waveguide, Flexible waveguide, Waveguide E plane, H Plane, Twisted Waveguide, Connectors etc.</b>			
a	C-Band, 90 degree rigid waveguide bend with CPR 137 F/G Flange connector (Length-0.30mtr max (each leg))			
	i) H-plane bend	1	No.	
	ii) E-plane bend	1	No.	
b	Cross Guide Directional Coupler for Frequency range 5.85 to 6.425 GHz with CPR 137 F/G Flange connector	2	Nos.	
c	C-Band, Twisted rigid waveguide, clockwise with CPR 137 F/G Flange connector (Length-0.30 mtr max)	2	Nos.	
d	Supply of Flexible Waveguide with CPR 137G Flange connector at one end and CPR 137F Flange connector at other end as per detailed below:-			
	i) Length-0.6 mtr with gasket and screw kit	2	sets	
	ii) Length 1.0 mtr with gasket and screw kit	2	sets	
e	Supply of Flexible Waveguide with CPR 137 F/G Flange connector as per detailed below.			
	i) Length-0.6 mtr with gasket and screw kit	2	sets	
	ii) Length 1.0 mtr with gasket and screw kit	2	sets	
f	Inter-connecting RF cables with connector from output port of RF Redundancy Switch to HPAs and various monitoring port of upconverters, Redundancy Switch, HPAs, TLT, Down converter etc to patch panel	1	set	
g	Supply and installation of aluminium duct or HDPE pipe as per site requirement of suitable size to take out hot air of each HPA from HPA room to outside the room (Minimum length-4 mtr)	1	job	
h	Essential item (if any) to complete the installation of Waveguide system	1	set	
i	Installation, Testing and System Integration of Waveguide system	1	Job	
<b>3</b>	<b>Power Supply</b>			
a	32 Amp 4 pole Industrial MCB	2	Nos.	
b	Copper I.T Power Supply cables with suitable rating for connection from existing Power Distribution Panel (UPS) to MDUs of HPA Rack.			
c	Any other essential items/Works to complete the Power supply system			
d	Installation, testing and integration of Power Supply System			

*Himanshu Goyal*

*lok*

*13*