



प्रसार भारती  
Prasar Bharati  
भारत का लोक सेवा प्रसारक  
India's Public Service Broadcaster  
कार्यालय: अपर महानिदेशक (अभि.) (उत्तरी क्षेत्र)  
Office of the Additional Director General (E) (NZ)  
आकाशवाणी एवं दूरदर्शन  
Akashvani & Doordarshan  
आठवां तल, सूचना भवन, सी.जी.ओ. कॉम्प्लेक्स, नई दिल्ली 110003  
8<sup>th</sup> floor, Sochna Bhawan, CGO Complex, New Delhi-110003



मत्स्यं शिवम् मन्दरम्

5(99)/11/NIT-26/AIR-EP

Dated: 19.06.2026

**Subject:** SITC of 3 Phase 4 Wire 40 KVA On-line uninterrupted power supply system for Akashvani Rampur, Jaspur, Kupwara, Gurez (under New Project), Amethi, Ayodhya, Agra, Lucknow, Kathua, Rajouri, Almora (under continuation of Central Sector Scheme), Prayagraj, Kanpur, Jalandhar, Rohtak, Mussorie, Poonch, Naushera, Bandha, Kota, Bikaner, Bathinda & Lakhimpur khiri (for AVM-NZ) (23Nos).

1. The budgetary quotation & drawings of the upcoming bid are enclosed herewith to offer comments, if any by prospective bidders/firms.
2. Bidders/firms are requested to provide information about content in respect of scope along with budgetary quote.
3. Bidders/firms may please submit the above detail on or before due date by e-mail to [rambirsingh1@prasarbharati.gov.in](mailto:rambirsingh1@prasarbharati.gov.in) or at following address.

Ram Bir Singh  
Assistant Engineer  
Room No. 899-C,  
O/o ADG (E)(NZ)  
Akashvani & Doordarshan,  
8<sup>th</sup> floor, CGO Complex,  
Sochna Bhawan, New Delhi-110003  
e-mail id: [rambirsingh1@prasarbharati.gov.in](mailto:rambirsingh1@prasarbharati.gov.in)

**Budgetary Quotation for:** SITC of 3 Phase 4 Wire 40 KVA On-line uninterrupted power supply system for Akashvani Rampur, Jaspur, Kupwara, Gurez (under New Project), Amethi, Ayodhya, Agra, Lucknow, Kathua, Rajouri, Almora (under continuation of Central Sector Scheme), Prayagraj, Kanpur, Jalandhar, Rohtak, Mussorie, Poonch, Naushera, Bandha, Kota, Bikaner, Bathinda & Lakhimpur khiri (for AVM-NZ) (23Nos).

**Due Date to offer Comments:** 24.06.2026

**Enclosed:**

1. Budgetary Quotation form & drawing of the upcoming bid is enclosed herewith to offer comments, if any by prospective bidders/firms.

  
19/06/2026

**Assistant Engineer  
For Additional Director General (E) (NZ)**



5(99)/11/NIT-26/AIR-EP

Date:19.06.2026

**Budgetary Quotation Form**

Please read carefully the terms and conditions given the enquiry quotation form.

**Subject:** SITC (Supply, Installation, Testing, and Commissioning) of 3-Phase, 4-Wire, 40 kVA Online Uninterruptible Power Supply (UPS) Systems for Akashvani Rampur, Jaspur, Kupwara, Gurez (under new project scheme), Amethi, Ayodhya, Agra, Lucknow, Kathua, Rajouri, Almora (under the continuation of the Central Sector Scheme), Prayagraj, Kanpur, Jalandhar, Rohtak, Mussoorie, Poonch, Naushera, Banda, Kota, Bikaner, Bathinda, and Lakhimpur Kheri (for AVM-NZ) — (23 Units).

Last date of receipt of budgetary quotation in this office: 24.06.2026 upto 12:00Hrs

| Sl. No | Description  | Qty. | Make | Model | Rate |
|--------|--|------|------|-------|------|
| 1.     | 40 kVA, IGBT/PWM based (Rectifier & Inverter), true on-line double conversion fully DSP controlled type UPS system (3-Phase, 4 Wire input – 3 Phase, 4 Wire Output) with remote status display panel with interface cables as per AIR Specifications.<br>[Including Transient Voltage Surge Suppressor (TV SS) in input & output. (ANSI/IEEE C62.41 1991 C1 (6KV @3KA))] |      |      |       |      |
| 2.     | 12 V Batteries of Sealed Maintenance Free (AGM-VRLA type) Battery Bank suitable to provide 15 minutes (minimum) backup (EOL) as per AIR Specification.<br>Minimum Battery Capacity: (45000V Ah minimum)<br>Tenderer to give:<br>No. of batteries with UPS:<br>Ah of each battery:<br>DC bus voltage:<br>Size of battery bank:  |      |      |       |      |
| 3.     | 60 kVA isolation Transformer as per AIR Specification.   |      |      |       |      |
| 4.     | Any other item required for the completeness of the UPS system.  |      |      |       |      |
| 5.     | Installation, Testing and Commissioning of the UPS system including double earthing as per electricity rules.  |      |      |       |      |
|        | <b>Optional Items:</b>   |      |      |       |      |
| 1.     | Recommended spares for one set of UPS System.<br>(Items wise details of offered and included material, items & part No. if any, are to be given by the tenderer.)  |      |      |       |      |

**Note:**

- Time of execution as per permission of Engineer in-charge at Akashvani Rampur, Jaspur, Kupwara, Gurez, Amethi, Ayodhya, Agra, Lucknow, Kathua, Rajouri, Almora, Prayagraj, Kanpur, Jalandhar, Rohtak, Mussoorie, Poonch, Naushera, Banda, Kota, Bikaner, Bathinda, and Lakhimpur Kheri.
  - Before submission of offer, detailed site visit undertaking of confirmation of site condition is required to access the quantum of scope and site specific requirements. Site visit may be carried out with consultation of I.O/Engineering head at Akashvani Rampur, Jaspur, Kupwara, Gurez, Amethi, Ayodhya, Agra, Lucknow, Kathua, Rajouri, Almora, Prayagraj, Kanpur, Jalandhar, Rohtak, Mussoorie, Poonch, Naushera, Banda, Kota, Bikaner, Bathinda, and Lakhimpur Kheri.
  - The bidder must be experienced in same kind of scope & shall submit documentary evidence with offer. The completion certificate is also to be attached issued by any Central and State Government agency, PSUs, Private organizations.  
(In case of SITC/SETC and specialized scope, the contractor should also have sufficient experience and shall submit the experience certificate of satisfactory completion of at least three similar works, each of value not less than 40% of the estimated cost put to tender or two similar works, each of value not less than 60% of the estimated cost or one similar work of value not less than 80% of the estimated cost, all amounts rounded off to a convenient full figure, in the last 7 years ending on the last day of the month previous to the one in which the tenders are invited”).
  - Execution of scope has to be completed without break in service at Akashvani Rampur, Jaspur, Kupwara, Gurez, Amethi, Ayodhya, Agra, Lucknow, Kathua, Rajouri, Almora, Prayagraj, Kanpur, Jalandhar, Rohtak, Mussoorie, Poonch, Naushera, Banda, Kota, Bikaner, Bathinda, and Lakhimpur Kheri.
  - The firm has to produce a list all such labour along with the address proof which are to be Employed Office on signing contract. The firm shall issue the identity cards to all such persons to facilitate the entry in at Akashvani Rampur, Jaspur, Kupwara, Gurez, Amethi, Ayodhya, Agra, Lucknow, Kathua, Rajouri, Almora, Prayagraj, Kanpur, Jalandhar, Rohtak, Mussoorie, Poonch, Naushera, Banda, Kota, Bikaner, Bathinda, and Lakhimpur Kheri.
  - Inspection will be carried out preferably in presence of Authorized representative of ADG (NZ), AIR & DD, 8th floor, Soochna Bhawan, CGO Complex, New Delhi-110003.
  - Any damage or misplace in equipment will have to be provided by the firm during execution.
1. Quantity of Material & Scope may increase or decrease as per actual requirement/constraints at site.
  2. Please read carefully the terms and conditions given in this Quotation Form.
    - a) GST No: .....
    - b) PAN No.....
  3. **Delivery at:** 3-Phase, 4-Wire, 40 kVA Online Uninterruptible Power Supply (UPS) Systems at Akashvani Rampur Rampur, Jaspur, Kupwara, Gurez, Amethi, Ayodhya, Agra, Lucknow, Kathua, Rajouri, Almora, Prayagraj, Kanpur, Jalandhar, Rohtak, Mussoorie, Poonch, Naushera, Banda, Kota, Bikaner, Bathinda, and Lakhimpur Kheri..
  4. **Consignee:** Installation officer, Akashvani Rampur, Jaspur, Kupwara, Gurez, Amethi, Ayodhya, Agra, Lucknow, Kathua, Rajouri, Almora, Prayagraj, Kanpur, Jalandhar, Rohtak, Mussoorie, Poonch, Naushera, Banda, Kota, Bikaner, Bathinda, and Lakhimpur Kheri..
  5. **Completion Period:** Completion of scope in good condition within 60days from the date of order.
  6. **Validity:** 120days
  7. **Payment terms:**
    - 97% Payment on completion/execution of scope in good condition at site.
    - Balance payment of 03% will be paid after guarantee/warranty period of one year. However, payment can be released against FDR/Account Payee Demand Draft/Banker's Cheque of equivalent amount in favour of Chief Engineer (NZ), Akashvani & Doordarshan New Delhi valid for guarantee period at least.
  8. **Performance Security:**
    - a. The firm/contractor should submit performance security deposit in the form of FDR from a schedule commercial bank valid for one year in favour of Chief Engineer (NZ), Akashvani & Doordarshan New Delhi.
    - b. The Performance Security Deposit shall be 03% of cost of the order/Agreement value.
    - c. For release of security deposit/performance security, the firm will submit his claim along with a certificate from the ultimate consignee that equipment supplied/SITC executed against this order has performed satisfactorily during its warranty/guarantee period and department have not suffered any loss/inconvenience on this account.
  9. **Declaration:** We declare that all the conditions as given in the Quotation form have been read by us and are acceptable.

Name (in capital) \_\_\_\_\_

Seal: (Signature of the Tenderer)

**PRASAR BHARATI  
(INDIA'S PUBLIC SERVICE BROADCASTER)  
DIRECTORATE GENERAL: ALL INDIA RADIO  
(PLANNING & DEVELOPMENT UNIT)**

\*\*\*\*\*

**SPECIFICATIONS FOR SITC OF 40 kVA, TRUE ON-LINE, DOUBLE CONVERSION, FULLY DPS CONTROLLED TYPE UNINTERRUPTIBLE POWER SUPPLY (UPS) SYSTEM (3-PHASE, 4 WIRE INPUT & 3-PHASE, 4 WIRE OUTPUT) ALONGWITH BATTERY BANK AND ISOLATION TRANSFORMER (FOR VHF FM TRANSMITTER SET UP)**

**CONTENTS**

| S. No. | Description  | Page No. |
|--------|--|----------|
| 1      | A. Essential Requirement for tenderers   | 1-2      |
| 2      | B. Essential Eligibility Criteria for tenderers                                  | 2        |
| 3      | Section 1.0, General Specifications  | 3 - 7    |
| 4      | Section 2.0, Essential features  | 7 - 9    |
| 5      | Section 3.0, Technical Specifications  | 10 - 16  |
| 6      | Section 4.0 (A), Schedule of Requirements/Materials (Un-Priced)                  | 17       |
| 7      | Section 4.0 (B), Schedule of Requirements/Materials (Un-Priced) (Optional Items) | 17       |
| 8      | Suggestive configuration of UPS system   | 18       |

**A. ESSENTIAL REQUIREMENT FOR THE TENDERERS:**

- (i) The tenderer should submit Schedule of Requirements/Materials for SITC without *price in the same format as given in AIR Specification* in the technical bid, failing which the tender shall be considered incomplete and is liable to be rejected.  
  
(ii) It is also mandatory to mention *Make & Model of the offered equipment* in the Schedule of Requirements/Materials of supply, failing which the tender shall be considered incomplete and is liable to be rejected.
- Each statement of the technical specification has to be complied with & supported by printed technical literature, technical data sheets, schematic drawings and technical manuals, duly signed & stamped by respective Original Equipment Manufacturer (OEM) and countersigned by the tenderer to assess the full merit of the offer, failing which the tender shall be considered incomplete and is liable to be rejected.
- The tenderer should submit the tender offer to AIR in the format given below, Section wise & Clause wise, in respect of all the Sections of technical specifications to assess the full merit of the offer, failing which the tender shall be considered incomplete and is liable to be rejected.

| S. No. of AIR Specifications (Section wise & Clause wise) | Details of AIR Specifications (Part/ Section wise & Clause wise) | Compliance (Yes/No) | The page no. of the tender offer, where the information/ supporting document is available. | Remarks |
|---|--|---------------------|--|---------|
| (1)   | (2)  | (3)                 | (4)  | (5)     |
|   |  |                     |  |         |

*R. Sharma*

*M. M.*

*Prakash*

*S. H. Jha*

|   |  |  |  |  |
|---|--|--|--|--|
| Section-1.0<br>Clause wise              |  |  |  |  |
| Section-2.0<br>Clause wise              |  |  |  |  |
| Section-3.0<br>Clause wise              |  |  |  |  |
| Section-4.0 (A) &<br>(B)<br>Clause wise |  |  |  |  |

4. The tenderer should also quote the rate/cost of individual items in the tender offer while submitting the offer in respect of spares (**OPTIONAL**) in commercial bid.
5. The complete Technical specifications (Section wise & Clause wise) compliance statement alongwith Schedule of Requirements/Materials (un-priced) must be signed & stamped on each page by the respective Original Equipment Manufacturer and countersigned by the tenderer in the tender document including the clarifications, if any, asked by All India Radio, failing which the tender shall be considered incomplete and is liable to be rejected.  
The manufacturer & tenderer should also mention their names in CAPITAL LETTERS & designation of the signatories, full address with pin code, phone number, fax number, e-mail addresses etc.
6. All the volumes of the entire technical bid must be page numbered.
7. The authorization and guarantee must be given by respective Original Equipment Manufacturer on their letterhead pad duly signed & stamped on each page. In case tender offer is from other than the Manufacturer, the tenderer must also give guarantee on their letterhead pad, duly signed & stamped on each page, failing which the tender shall be considered incomplete and is liable to be rejected.
8. Any change in the AIR technical specifications format or language or in parameters or of any other nature including the deletion of technical specifications clause, words, lines in the technical specifications compliance statement by the Original Equipment Manufacturer / tenderer will not be acceptable to AIR and the tender is liable to be rejected.
9. *Optional items will not be considered for ranking purpose.*

**B. ESSENTIAL ELIGIBILITY CRITERIA FOR TENDERERS:**

**The criteria for this will be decided by the Zonal Office.**

  
(P.K. Sharma, AE)

  
(Manzoor Ali, AE)

  
(Aditya Chaturvedi, DE)

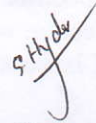
  
(S. Hyder, DE)

**SECTION-1.0**

**GENERAL SPECIFICATIONS:**

**Note :** Please refer tender documents for general terms and conditions of contract for SITC works including all the commercial aspects like Packing and Packing List, Insurance and Marine Risk etc., Payment terms, Penalty/Compensation for Delay, Damages and Liabilities, Time Period and Extension for Delay, Foreclosure of Contract due to Abandonment or Reduction in Scope of Supply, Cancellation of Contract in Full or Part, Recovery of Security Deposit, Performance Guarantee, Unsatisfactory Workmanship, Damages Incurred During Transit, Tenderer Liable for Damages, Defects, Recovery of Compensation, Ensuring Payment and Amenities, Tenderer to Indemnify Government against Patent Rights, Release of Security Deposit, Safety Code, insurance from manufacturer's works/factory to respective site etc **i.e. in totality.**

**1 SCOPE:**

The specifications are for the SITC of 40 kVA, True on-line, double conversion (defined as VFI in the IEC 62040-3 UPS Specifications), fully DSP controlled type Uninterruptible Power Supply (UPS) (3-Phase, 4 Wire input, 3-Phase, 4 Wire output) along with Battery Bank and Isolation Transformer for use in AIR FM transmitters (power factor better than 0.8). The UPS system has to operate in conjunction with the existing Building Electrical System and Diesel Generator (62.5 kVA) to provide power conditioning, back-up power protection, and power distribution for the critical loads.

**2 GENERAL:**

The UPS should be reliable and stable in operation under Indian tropical conditions. In India, climate may be extremely humid and dusty besides varying from very cold to very hot. It should have a front panel LCD display to show various parameters of the system to ease the monitoring.

The UPS system shall be capable of running in stand-alone Mode as per the attached configurations shown in Fig. 1. UPS system is to be supplied with 15 minutes back up time at full rated capacity.

**3 INSPECTION:**

(a) All the equipment to be supplied against the supply order for this tender shall be subjected to inspection at New Delhi/ manufacturer's facility by AIR.

(b) The installation shall be subjected to inspection at site by AIR. The firm shall submit all the drawings, wiring/ connection diagrams etc. at the time of inspection. The Manufacturer shall provide all technical equipment required for inspecting the system to the inspector.

(c) The complete Acceptance Test Procedure/Protocol (ATP) will be prepared by the OEM and submitted to concerned Zonal office for approval **within one month** of issue of Acceptance of Tender. ATP will also indicate full details of setup for measuring/testing equipments to be deployed during the performance measurements/inspection. The **approved ATP** shall form the basis for performance measurements/inspection to be carried out.

**4 LANGUAGE/UNITS:**

All information supplied by the tenderer and all markings, notes, designation on the drawings and associated write-ups including Instruction Manuals shall be in **"English language" only.**

  
(P.K. Sharma, AE)

  
(Manzoor Ali, AE)

  
(Aditya Chaturvedi, DE)

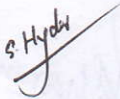
  
(S. Hyder, DE)

All dimensions and units on drawings and all references to weights, measures and quantities shall be in **SI units**.

**5 INFORMATION TO BE SUPPLIED WITH THE TENDER:**

- (i) The complete technical specifications (Section wise & Clause wise) compliance statement alongwith Schedule of Requirements/Materials (un-priced), duly signed & stamped on each page by the respective Original Equipment Manufacturer and countersigned by the tenderer as per the format given above in clause A (3).
- (ii) Complete printed technical literature, technical data sheets, schematic drawings and technical manuals of the offered equipments, duly signed & stamped by the respective Original Equipment Manufacturer and countersigned by the tenderer in support of compliance statement.
- (iii) Schedule of Requirements/Materials (un-priced) for SITC of UPS & accessories in the same format as given in AIR Specification. The tenderer must quote all items.
- (iv) Descriptive information and complete details of each equipment offered shall be given by the tenderer.
- (v) Country of Origin, Make, Type & Model of all the Equipments/items offered should be mentioned including the name & address of their vendors.
- (vi) A copy of the Technical Manual must be enclosed with technical bid for assessing the Equipment offered. The Technical Manual must include at least the details given below:

5.1 **Installation Manual:** A detailed installation manual for the installation of UPS System should contain at least the following details:

- a) A floor equipment layout plan with dimensions in meters for installing the UPS System in the hall. All the dimensions of hall with ceiling height, and equipment to be installed should be provided.
- b) Isometric view of UPS System and allied equipment diagrams with dimensions in meters are to be provided.
- c) All installation drawings with dimensions are to be provided.
- d) All mechanical assembly drawings of the UPS System with dimensions are to be provided.
- e) All the views, i.e. Front, rear, top and side, of the UPS System with dimensions are to be provided.
- f) A detailed diagram showing the airflow Inlet to the UPS and the out let route should be provided.
- g) All unpacking/ installing details of the UPS are to be provided.
- h) A detailed writes up in English regarding installing the UPS System along with its associated equipment items should be provided.
- i) The procedure of alignment and adjustment of various assemblies, sub- assemblies of UPS System to be described in details in the installation manual.
- j) The procedural details of alignment of all stages, control circuits and input/output stage of the UPS System should be described with practical examples in this manual.
- k) All do's and don'ts which are essential for safe installation of the UPS System should be described in the installation manual.

  
(P.K. Sharma, AE)

  
(Manzoor Ali, AE)

  
(Aditya Chaturvedi, DE)

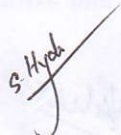
  
(S. Hyder, DE)

- l) A detailed description with all relevant circuit diagrams for the control circuit of the UPS should be provided.
- m) The detailed procedure and possibilities of By-passing UPS unit and control circuit should be described with diagrams in this manual.
- 5.2 **Operation and Maintenance Manual:** A detailed operation and maintenance manual with all drawings, circuit diagrams, of all PCB's assemblies, subassemblies are to be provided.
- a) All details regarding putting "ON" with the sequence of operation of the UPS are to be provided in the manual.
- b) The details of all electrical/electronic circuits in various stages of the UPS used along with their write-ups are to be provided in this manual.
- c) All precautions and detailed instructions regarding operation of the UPS System should be provided in this manual.
- d) The detailed description with examples for taking various measurements with the measuring equipment along with the test bench details for measuring various parameters for the UPS should be provided in the manual.
- e) The various tests and measuring equipment required and essential for the routine maintenance and calibration along with the procedure for taking such measurement calibration should be provided in the manual.
- f) The lists of all parts/components/assemblies/subassemblies with their part numbers and with the source of supply with supplier's address etc. are to be provided in this manual.
- g) The details of ordering specifications for all parts/components/subassemblies/PCB/units should be listed in this manual to facilitate reordering of spares as and when required during the life time of this UPS System.
- h) The details of self-check for the UPS System and internal calibration are to be described in the manual.
- i) The detailed procedure for trouble shooting of the UPS System preferably up to component level should be available in the manual. Various test fixtures and accessories required for the maintenance/ repair of the UPS System should be clearly described and detailed out in this manual. The systematic trouble shooting/ fault tree and flow diagram should be provided for diagnosis of the fault with its remedial measures in this manual.
- j) The various assemblies/sub assemblies, PCBs, Parts and Components should be clearly marked to define its functions. The schematic diagrams and references should be described in such a way so that the parts/assemblies/PCBs etc. can easily be identified from the components layout diagram provided in the manual.
- k) All the controls, switches, knobs, interfaces and indications should be clearly marked to show their circuit designation and functions.
- l) Accessibility for testing, replacing of components, ease of maintenance, calibration and adjustment should be the main design features of the UPS System.
- m) The manual should have description regarding various interfaces, connectors, connecting cables and accessories required for the satisfactory function of the UPS System. All such items required should be provided by the manufacturer along with the UPS system.

  
(P.K. Sharma, AE)

  
(Manzoor Ali, AE)

  
(Aditya Chaturvedi, DE)

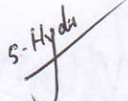
  
(S. Hyder, DE)

**6. INFORMATION TO PRECEDE DESPATCH OF EQUIPMENT:**

Following information should be supplied to concerned Zonal office and each of the consignees prior to dispatch of equipment:

- (a) Detailed list of equipments under dispatch.
- (b) Photograph showing location of various units/subunits with item numbers marked thereon.

**7. INFORMATION TO BE SUPPLIED BY THE TENDERER WITHIN ONE MONTH AFTER ISSUE OF ACCEPTANCE OF TENDER:**

One set of Technical Manuals (Installation, Testing, Commissioning, Operation & Maintenance, including theory of operation and fault diagnosis, circuit diagrams) **COLOUR** printed and duly bound for UPS system including Battery Bank and Isolation Transformer along with soft copy on CD must be supplied to concerned Zonal Office.

**8. INSURANCE AND MARINE RISKS ETC.**

Please refer to commercial terms.

**9. INFORMATION TO BE SUPPLIED ALONGWITH EQUIPMENT:**

Two Sets of Technical manuals (for Installation, Testing, Commissioning, Operation & Maintenance, including theory of operation and fault diagnosis, circuit diagrams) **COLOUR** printed and duly bound for UPS system including Battery Bank and Isolation Transformer alongwith final performance measurements with soft copy on CD shall be supplied to concerned Zonal office and consignee.

**10. GUARANTEE:**

The tenderer shall submit with his tender an undertaking to accept the following guarantees:

- (i) The guarantee of the Equipments/items shall be 36 months from the date of commissioning.
- (ii) A guarantee that the equipment supplied will be in accordance with these specifications, varied only to the extent stated in his tender and agreed to in the contract.
- (iii) A guarantee to make good within 10 days at tenderer's expense, if any component which becomes defective under normal operating conditions during guarantee period.
- (iv) A guarantee to supply all components for a period of ten years from the date of acceptance of Equipments/items, at rates at which these are being supplied by him to other customers and also should match prices of original manufactures of these components prevailing at that time.
- (v) If at any stage during next 10 years, the manufacturer stops production of this model of Equipments/items, the tenderer/OEM shall intimate All India Radio in advance to enable the latter to stock the critical items.

**11. MAINTENANCE SUPPORT AND SPARES:**

- (a) The minimum recommended essential spares shall be quoted separately by the tenderer.
- (b) The minimum recommended essential spares may be based on predicted rate of failure.

In case, the tenderer quotes the optional items as 'Set', the details of the components/items offered in the 'Set' must be spelt out clearly including their Make, Model and quantity.

**12. COMPLETION OF SITC:**

The project, consisting of Supply, installation and commissioning of the Online UPS, will have to be implemented on turnkey basis in three months time from the date of placement of order.

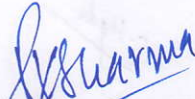
  
(P.K. Sharma, AE)

  
(Manzoor Ali, AE)

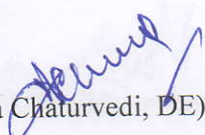
  
(Aditya Chaturvedi, DE)

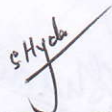
  
(S. Hyder, DE)

### 13. INSTALLATION AND COMMISSIONING:

The firm shall be ready to carry out the installation work at any time of a day (24 Hrs) and any day of the week (7 days) as permissible on the particular site.

#### Section-2.0

#### ESSENTIAL FEATURES:

1. (a) The system should be fully DSP controlled in all respects (i.e. rectifier control, inverter control, display, digital diagnostics), solid-state type, utilizing true On-Line Double Conversion technology (high frequency PWM using IGBT Rectifier & inverter section)  
(b) The system should be capable of providing continuous high quality sinusoidal waveform power for electronic equipment loads.  
(c) The system should conform to voltage frequency independent technology.
2. The DSP based controller should have following characteristics:
  1. Diagnostic monitoring achieved by Fast Fourier Transform (FFT) of spectrum analysis
  2. Adaptive control by having the speed to monitor and control the system concurrently
  3. Real time generation of smooth, near optimal reference profiles and move trajectories
  4. Control power switching and inverters and generate high resolution outputs
3. The UPS should offer low input current harmonic distortion (THDI), good regulation, excellent transient response and high stability.
4. (a) The system should have a monitoring panel (LCD Based) with various types of fault alarms and metering functions including:
  - i. Output voltage, current & frequency.
  - ii. Input voltage, current & frequency.
  - iii. Bypass Voltage, Current & frequency.
  - iv. Battery capacity, backup time left & bad battery indication.
  - v. Temperature of System, Inverter section and Rectifier section.

b) The UPS system should display both RMS value and Peak value of load current.

c) The UPS system should have facility to generate aural alarm for bad Battery condition.
5. a) The system should have wide input voltage and input frequency tolerance as specified in Rectifier section.  
b) Transient Voltage Surge Suppressor (TVSS) should be provided at the input & output of the UPS System.
6. The system should have provision for controlling all the three phases individually, even in case of 100% unbalancing at the output with even 0% load on one phase. There should be no change in regulation in phase voltage with 100% unbalancing.
7. The system should be capable of supplying energy to load from commercial mains without any break in case of phase reversal at the input. It should also generate aural and visual alarm in such a case.
8. a) The system should have provision of protection for
  - (i) Input under voltage

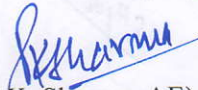
  
(P.K. Sharma, AE)

  
(Manzoor Ali, AE)

  
(Ananya Chaturvedi, DE)

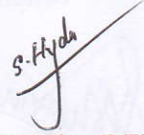
  
(S. Hyder, DE)

- (ii) Input Over Voltage
  - (iii) Output Over Voltage
  - (iv) Output Over load
  - (v) Output short circuit
  - (vi) Battery under Voltage
  - (vii) Over temperature
  - (viii) DC Over current
- b) The system should generate aural and visual alarms for above-mentioned conditions.
9. The system should have Controls as
- (i) Input Circuit Breaker
  - (ii) Bypass Circuit Breaker
  - (iii) Maintenance Bypass Switch
  - (iv) Inverter ON / OFF Switch
  - (v) Alarm acknowledge switch
10. (a) The system should have facility to store the Logs of the events being monitored by monitoring system.  
(b) The UPS system should have the capability to store a minimum of last 100 events.  
(c) The UPS should have in-built digital fault diagnostic through stored events in UPS system.
11. The system should also include an external 60 kVA Isolation Transformer alongwith the UPS to provide protection from electrical surges/noise (inherent and generated both) present in the input power supply.
12. The firm should specify the Nos. & type of desired batteries, which shall be part of the system to be offered. **[The batteries of known & reputed world-class manufacturer only will be accepted.] The sealed maintenance free-batteries AGM-VRLA type shall only be acceptable. The detailed technical specification of batteries with their working life is also to be specified and provided with the offer.**
13. A- The battery charger should have provision of
- (i) Monitoring battery temperature and accordingly adjusting the charging level to enhance the battery life.
  - (ii) Programmable battery charging which can be programmed to enhance battery life.
- B- Battery charging current should be adjustable from 10% to 80% through Microprocessor & displayed.
- C- For battery sizing calculation, temperature is required to be taken as 0°C.
14. The system should have communication port RS-232 and should be compatible to integrate with NMS. Suitable software for monitoring & diagnostics etc. should be supplied.
15. The system should be designed with scientific forced air-cooling for proper ventilation. Acoustic noise level should be kept at minimum.
16. The UPS system output should be isolated from the DC circuit of the UPS.
17. The firm should specify the total area requirement for installation of the system including batteries. A floor layout plan should be attached.

  
(P.K. Sharma, AE)

  
(Manzoor Ali, AE)

  
(Aditya Chaturvedi, DE)

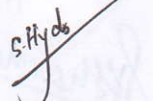
  
(S. Hyder, DE)

18. The system that shall be quoted against this tender should include all switchgears, cables, earthing etc. Terminals for input 3-phase, 4 Wire, power supply & output power supply should be provided.  
Power supply sub distribution in the output is not in the scope of this tender. A block-schematic diagram with all items should be provided.
19. The system that shall be quoted against this tender should be capable of running continuously round the clock, seven days a week without interruption or failure.
20. The UPS System quoted must conform to the latest international standards of safety and EMC. The conformance to such standards (indicating standard's name & number) must be stated in compliance statement. A certificate issued to OEM by authorized international/ national agencies should be submitted along-with the declaration from OEM in this regard. In general, following standards should be met: -
  - A. Safety: IEC 62040-1 / EN 50091-1
  - B. Emission and Immunity: IEC 62040-2, Class A / EN 50091-2 (Class A)
  - C. Performance: IEC 62040 -3/ EN 50091 - 3
  - D. CE-Marked in accordance with EEC directives 73/23 "low voltage" and 89/336 "electromagnetic compatibility"
21. The UPS manufacturer must be ISO 9001-2000 certified company. A copy of the certificate should be enclosed with the offer.

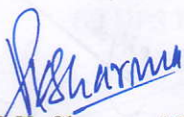
  
(P.K. Sharma, AE)

  
(Manzoor Ali, AE)

  
(Aditya Chaturvedi, DE)

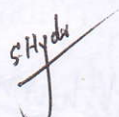
  
(S. Hyder, DE)

**Section-3.0**

**TECHNICAL SPECIFICATIONS:**

**A. SYSTEM**

1. Technology:

The UPS shall be designed to operate as **true on-line, double conversion fully DSP controlled type UPS** strictly as per the definition of IEC 62040-3 as follows:

**a) Normal Operation:**

The UPS inverter should continuously supply the critical AC load. The rectifier & charger should take power from the AC input source, convert it to suitable DC and supply to the inverter as well as charge the Batteries on Automatic Float cum Boost Mode.

**b) Upon Mains Failure:**

Upon failure of AC input power, the critical AC load should continue to be supplied by the inverter, which should obtain power from the battery. There shall be no interruption in power to the critical load upon failure or restoration of the AC input source (Mains/ DG).

**c) Upon Mains Restoration:**

Upon restoration of AC input power, the Rectifier/Charger should automatically restart walk-in and gradually take-over the supply to inverter and charging to the battery.

**d) Static Bypass:**

UPS Module should have inbuilt 100% rated static Bypass Line.

All the loads should be transferred to the Static Bypass Line of the UPS without any break for the following conditions:

- i. If the UPS fails
- ii. If overload beyond 150% for 1 minute is faced by the UPS
- iii. If UPS sense over temperature (i.e. inverter exceeding 65°C simultaneously).
- iv. If the UPS inverter is put-off

2. MTBF of the System:

Bidder to specify and justify MTBF of the system

3. Capacity:

40 kVA at power factor 0.8

**B. RECTIFIER SECTION**

1. (a) Technology

**Fully DSP Controlled IGBT Rectifier with input filters to reduce the harmonics.**

2. Input

3-phase, 4-wire plus Ground

3. Input Voltage

320 to 460 V (at full load)

4. Input Frequency

47 – 53 Hz

5. Input Power factor

> 0.96

6. Input Current Harmonic Distortion (THDi)

≤ 4%

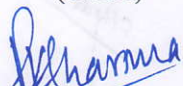
  
(P.K. Sharma, AE)

  
(Manzoor Ali, AE)

  
(Aditya Chaturvedi, DE)

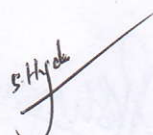
  
(S. Hyder, DE)

- 7. Soft start (0-100%) > 10 Sec
- 8. DC ripple voltage < 1%

**Note: Bidder should Specify the following Parameters for quoted UPS system**

- i) Rectifier Input current (Max.)
- ii) Max. Rectifier output current
- iii) Rated Output current (with battery fully charged state)
- iv) Max. Output Voltage

**C. INVERTER:**

- 1. **Technology** **Fully DSP based IGBT/PWM Inverter**
- 2. **Output Voltage** 3-phase, 4-wire plus Ground
  - 1. Nominal: 380V- 415V AC (adjustable), 50Hz
  - 2. Static: 400 ± 1% V AC, 50Hz
- 3. **Output voltage regulation:**
  - a) 100% Balanced load < ±1%
  - b) 100% Unbalanced load ± 2%
  - c) Transient response (100% step loading) < 5%
  - d) Recovery time to steady state (< ± 1%) < 5 msec.
- 4. **Output frequency regulation**
  - a) Line Connection: ± 1% (meeting input frequency range of 47-53 Hz.)
  - b) Self Connection: ± 0.05%
- 5. **Overall Efficiency:** >90% (for all loads from 50% to 100%)  
**(From I/P to O/P of the U.P.S. system)**
- 6. **Output voltage Distortion:** < 1% linear load,  
(at rated load) < 4% non-linear load with **3:1 crest factor**
- 7. **Audible noise level at 1 metre** 60 dBA or better
- 8. **Overload capacity:**
  - (a) Inverter Upto 125% 10 min  
Upto 150% 1 min
  - (b) Bypass Mode Continuously upto 135% of rated current  
135% to 170% of rated current for 1 min  
> 170% of rated current for 2 seconds
- 9. **RFSuppressions:** As per BIS & EMC standard.
- 10. **Computer Interface:** RS 232 Interface
- 11. **Online Battery testing:** Required
- 12. (a) Mains failure,  
(b) Battery Low,  
(c) UPS Fault Tenderer to provide Audio/Visual alarm at remote location (maximum distance 100 meter) in addition to local.

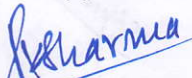
  
(P.K. Sharma, AE)

  
(Manzoor Ali, AE)

  
(Aditya Chaturvedi, DE)

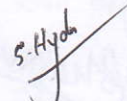
  
(S. Hyder, DE)

13. Front panel Display  
(Please submit the details of front panel display)

LED mimic with LCD display. The LCD should display the following:

- a) Input side:
  - i) Voltage
  - ii) Current
  - iii) Frequency
- b) Output side:
  - i) Voltage
  - ii) Current (RMS value) & Peak value.
  - iii) Frequency
- c) Intermediate DC:
  - i) Voltage
  - ii) Current
  - iii) Remaining time (in minutes)
- d) Bypass:
  - i) Voltage
  - ii) Current
  - iii) Frequency
- e) Alarm History

  
(P.K. Sharma, AE)

  
(Manzoor Ali, AE)

  
(Aditya Chaturvedi, DE)

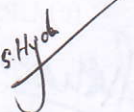
  
(S. Hyder, DE)

**D. BATTERY BANK & BATTERY**

- |     |  |  |
|-----|--|--|
| 1.  | Battery Bank Capacity                                    | Minimum 45,000 VAh   |
| 2.  | Nominal output current capacity                          | Minimum 65 Ah  |
| 3.  | No. of Battery String                                    | 1 Set complete   |
| 4.  | DC Voltage of the battery bank                           | Should be Minimum 480 V  |
| 5.  | Type:  | 12 V Batteries of Sealed Maintenance Free ( <b>AGM-VRLA</b> ). (Please submit the catalogue of offered battery with its detailed specifications along with the charging & discharging characteristics and Graphs from the OEM).                                    |
| 6.  | Backup time:   | Minimum 15 minutes (at the End of Life (EOL) of Battery) for 100 % load with each UPS system   |
| 7.  | Charging Voltage   | Float: 13.5±0.1 V per Battery at 27°C<br>Boost: 13.8±0.1 V per Battery at 27°C   |
| 8.  | Cutoff Voltage   | 1.70-1.75 V per Cell (should be Selectable)  |
| 9.  | Floating Voltage regulation between no load & full load. | 1% or better.  |
| 10. | Codes & Standards  | The supplying battery manufacturer shall be ISO 9001/14001 certified. The battery design shall be of field proven technology. The manufacturer shall have 5 years of field experience. Copy of Certificate for 'AGM-VRLA Battery' must be attached with the offer. |
| 11. | Design   | All batteries within the battery string shall be of the same manufacturer and model. The batteries shall be "Sealed Maintenance Free ( <b>AGM-VRLA</b> )" type.  |
| 12. | Life   | 10 years designed life at 27°C on full float.  |
| 13. | Life Cycling Characteristics                             | Each battery shall be designed to provide 4000 cycles at 20% depth of discharge (DOD) at 27°C and 1200 cycles at 80% DOD at 27°C.  |
| 14. | Deep Discharge   | Following an equalization charge, battery shall be capable of being recharged to rated capacity from a discharge down to zero volt per cell.   |
| 15. | Recharge Rate  | The battery shall be capable of a 90% recharge within 12 hours   |
| 16. | Operating Temperatures and altitude                      | The battery shall be capable of operating in temperatures ranging from 0°C to +40°C. Battery shall withstand hard freezing without damage to the alloy, plates, or cell container assembly. The battery shall be capable of  |

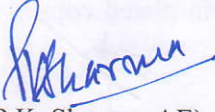
  
(P.K. Sharma, AE)

  
(Manzoor Ali, AE)

  
(Aditya Chaturvedi, DE)

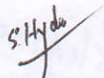
  
(S. Hyder, DE)

- operating at a maximum of 3000 M from ground level (AMSL).
17. Gassing No special ventilation shall be required under normal operating conditions. No separate "battery room" shall be required to house the battery unit.
18. Battery Orientation Battery bank shall have clear removable covers to facilitate visual inspections and allow ease of service.
19. Self-Discharge The battery shall have a maximum self-discharge rate of 0.5-1.0% per week at 27°C.
20. Construction/  
Functional Description **Pressure Relief Valve**  
Each battery shall have a self re-sealing pressure regulation valve, which operates at specified pressure. A flame arrester shall be incorporated in the valve designed to diffuse the Hydrogen gas escaped during charge and discharge. The valve shall be such that it cannot be opened without a proper tool. The valve shall be capable to withstand internal battery pressure specified by the manufacturer.
21. Housing The Battery system should be installed & supplied with MS Racks.
22. Product Identification Label Each battery shall have a self-adhering label identifying the product manufacturer, model and nominal Amp-Hour capacity. The label must be readily visible from the front of the battery. The label shall not wear out throughout the life of the battery.
23. Capacity Testing Each battery shall be capacity tested at the manufacturing facility as per standard battery testing procedure. For each battery, battery performance tables and curves shall be submitted with the supply. The curves may be obtained by test or by calculation.
24. Leak Detection Integrity of the container and post seals shall be verified in the battery manufacturing process using an automated helium leak detection process.
25. Seismic Requirements Batteries shall be packaged in steel modules that meet Seismic requirements when stacked horizontally.
26. Accessories Each battery shall be furnished with the following accessories:  
1. Each battery system shall include the necessary inter-battery and inter-module connectors and terminal plates. The connectors shall be lead-tin plated copper and shall

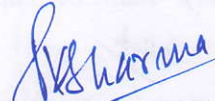
  
(P.K. Sharma, AE)

  
(Manzoor Ali, AE)

  
(Aditya Chaturvedi, DE)

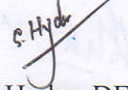
  
(S. Hyder, DE)

include stainless steel hardware.

2. One set of numerals (one numeral per battery) suitable for permanent attachment to batteries.
3. Assembly and connection drawings.
4. Each module shall include an easily removable transparent "snap on" safety shield to cover all connectors

27. Recycling services

The manufacturer must provide worldwide recycling services to properly dispose of spent lead-acid batteries. These services must include proper instructions for the packaging, transportation, and beneficial recycling as required meeting E.P.A. guidelines (or other applicable agencies) for the safe handling of lead-acid batteries. Documentation of disposal must be provided.

28 Max. Battery Charging current with nominal load

To be specified  
(Battery charging current should be selectable from the front panel of UPS system upto maximum value)

29. The bidder should submit battery sizing calculation justifying following points:

- No. of Batteries
- Capacity of Battery (Ah), (By considering the K-factor, efficiency of the system, Temperature correction factor, Ageing correction factor, etc.)
- DC bus voltage

The total required area for battery installation should also be mentioned.



(P.K. Sharma, AE)



(Manzoor Ali, AE)

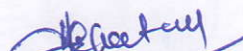

(Aditya Chaturvedi, DE)

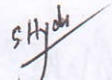

(S. Hyder, DE)

#### E. ISOLATION TRANSFORMER

The Isolation Transformer should be three phase, naturally air cooled type, housed in one steel cubical provided with cast iron wheels at bottom and should have hooks for lifting the unit. The cubical enclosing the Isolation Transformer should have sufficient openings (doors and removable covers) for ease of operation and maintenance of the system.

- |                                |  |
|--------------------------------|--|
| 1. AC Input:                   | Delta 3-phase, 400±10% (phase to phase)                          |
| 2. AC output:                  | Star 3-phase, 400±10% (phase to phase)<br>230 (phase to neutral) |
| 3. Frequency:                  | 47 to 53 Hz  |
| 4. Capacity:                   | 60 kVA   |
| 5. Duty cycle and use          | 24×7 Continuous, Indoor  |
| 6. Common Mode Noise Rejection | Better than 110 dB   |
| 7. Inter winding capacitance   | Less than 0.005 pF   |
| 8. Insulation resistance       | More than 500 Mega $\Omega$ at 500V                              |
| 9. Terminals                   | Studs on fiber glass plate at rear                               |
| 10. Cable entry                | Bottom   |

#### F. ENVIRONMENTAL CONDITION

- |  |                |
|--|----------------|
| 1. Operating Ambient Temperature         | 0°C to 40°C    |
| 2. Storage/Transport Ambient Temperature | - 25°C to 55°C |
| 3. Relative Humidity                     | 90%            |

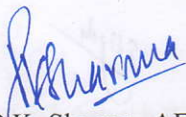
  
(P.K. Sharma, AE)

  
(Manzoor Ali, AE)

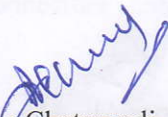
  
(Aditya Chaturvedi, DE)

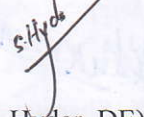
  
(S. Hyder, DE)

**Section-4.0(A)**

**Schedule of Requirements/Materials unpriced** (Schedule of Requirements/Materials must be in the format given below for technical and commercial quotes).

{The tenderer must quote all items}

| S. No. | Description   | Make | Model | Qty. |
|--------|---|------|-------|------|
| 1)     | 40 kVA, IGBT/PWM based (Rectifier & Inverter), true on-line double conversion fully DSP controlled type UPS system (3- Phase, 4 Wire input - 3 Phase, 4 Wire Output) with remote status display panel with interface cables as per AIR Specifications<br>[Including Transient Voltage Surge Suppressor (TVSS) in input & output. (ANSI/ IEEE C62.41 1991 C1 (6KV @ 3KA))] |      |       |      |
| 2)     | 12 V Batteries of Sealed Maintenance Free (AGM-VRLA type) Battery Bank suitable to provide 15 minutes (minimum) backup (EOL) as per AIR specification.<br>Minimum Battery Capacity: (45000VAh minimum)<br>Tenderer to give:<br>No. of batteries with UPS:<br>Ah of each battery:<br>DC bus voltage:<br>Size of battery bank:  |      |       |      |
| 3)     | 60 kVA Isolation Transformer as per AIR specification.  |      |       |      |
| 4)     | Any other item required for the completeness of the UPS system.   |      |       |      |
| 5)     | Installation, Testing and Commissioning of the UPS system including double earthing as per electricity rules.   |      |       |      |

**Section-4.0(B)**

**Schedule of Requirements/Materials unpriced (Optional items)** (Not to be considered for Ranking)

| S. No. | Description  | Make | Model | Qty. |
|--------|--|------|-------|------|
| 1)     | Recommended spares for one set of UPS System.<br>(Items wise details of offered and included materials, items & part No. if any, are to be given by the tenderer). |      |       |      |

All India Radio at its own discretion may procure spares for a value not exceeding 10% of the cost of equipments. The tenderer should quote all the essential spares.

  
(P.K. Sharma, AE)

  
(Manzoor Ali, AE)

  
(Aditya Chaturvedi, DE)

  
(S. Hyder, DE)

*Sharma*

**FIGURE -1  
UPS SINGLE MODULE -SUGGESTIVE  
CONFIGURATION**

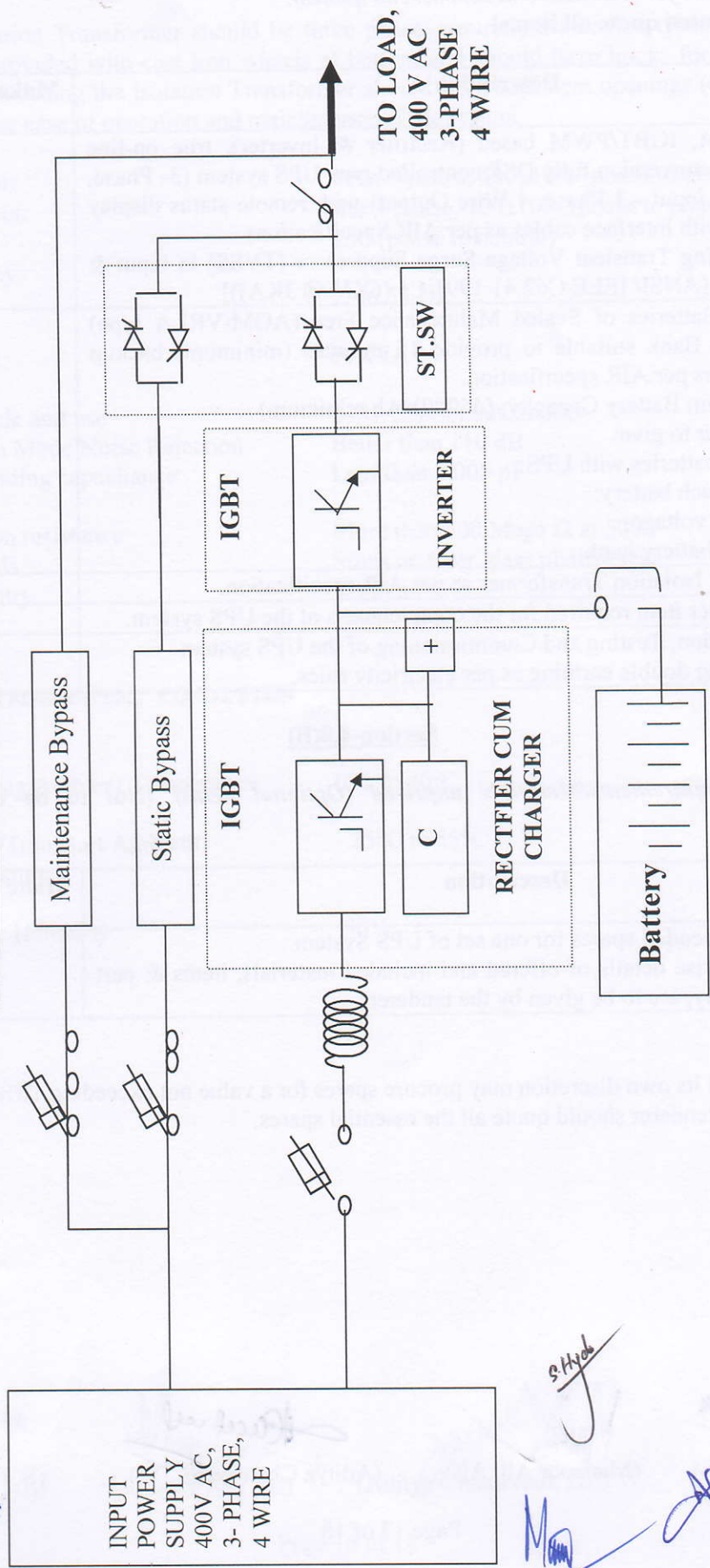

*Sharma*  
*Sharma*